



///ADVENT®

**Universal High Brightness Full View Rearview
Mirror with 7.3" Wide Screen Monitor**

User manual
RVM740

User's Manual

The product is intended to assist in safe driving and to allow the driver to have a broader rear view while the vehicle is in reverse. You, as the driver, are solely responsible for the safe operation of your vehicle and the safety of your passengers according to local traffic regulations. Do not use any features of this system to the extent it distracts you from safe driving. Your first priority while driving should always be the safe operation of your vehicle. Audiovox Electronics Corporation cannot accept any responsibility whatsoever for accidents resulting from failure to observe these precautions or safety instructions.

1. This product utilizes high voltage. Any unauthorized modifications or damage to the product may result in electrical shock. Handle all components with care. Inspect regularly for damage to components and cabling.
2. You are responsible for ensuring that the installation of this product does not void or affect the vehicle manufacturer's warranty. Voxx Electronics Corporation or its subsidiaries are not liable in full or in part for improper installation resulting in loss or damage to your property, or for voiding all or part of the vehicle manufacturer's warranty.
3. Do not apply excessive force to any of the components contained within this kit. Excessive force used before, during or after installation that results in a damaged or non-functional part will void all warranties.
4. Please follow the procedures in this installation manual. Improper installation or modification of this product will void all warranties.

NOTE: When cleaning the mirror do NOT spray the mirror directly with cleaner. Use a soft cloth with screen cleaner applied lightly, and wipe. DO NOT SOAK the screen. Too much moisture could damage the electronics Inside and this is not covered by warranty.

WARNING: Using the 2nd or 3rd input to watch video of any kind while driving is always dangerous and may be illegal. The mirror monitor is not designed to be used this way. If used for these purposes check all local laws covering this type of use.

Table of contents

Chapter one: Product Introduction	1
1.1 Contents	1
1.2 Features	1
1.3 Specifications	1
1.4 Operation	2
Chapter two: Installation and Wiring	5
2.1 Removing the original mirror	5
2.2 Installation	6
2.3 Wiring	7
2.4 Display Modes	9
Chapter three: Adjustable Guidelines	10
3.1 Understanding The Guide Lines	10
3.2 Camera Position and Vehicle Width Guide Line Adjustment	10
3.3 How to adjust the guide lines	11
Chapter four :Menu Settings	12
4.1 Remote control	12
4.2 Menu settings	12

Chapter one: Product Introduction

1.1 Contents

The RVM740 box contains the following items:

- Rear-view mirror monitor
- Wire harness
- User's manual
- Wire cover
- Remote control W/CR2025 battery(included)
- 2 additional mirror mounting adapters

1.2 Features

- 7.3" High Brightness Wide Screen Monitor/Mirror
- 3-way video input including Back-up Camera and 2 Video Inputs
- Automatic Monitor Brightness Adjustment
- Split View for second and third video inputs
- 4.0 mm glass and 3 OEM style mounting brackets
- Adjustable backup guide lines
- Remote control for user selectable features

1.3 Specifications

- Screen size: 7.3 inch Wide Screen
- Display screen type: TFT-LCD
- Resolution: 1280(H) x 390(V)
- Working voltage: DC 10V – 16V DC
- Working temperature: -20°C~+75°C
- Signal system: PAL/Auto/NTSC

1.4 Operation



1	7.3 Inch ultra high brightness display screen
2	Ambient light sensor
3	Display screen aux input power on/off
4	Power indicator
To Activate touch screen controls – Lightly touch the left side of the screen to illuminate buttons.	
5	Short press "R" to view the Back-up Camera. This function is locked out while in Reverse Gear. * The camera must be connected to constant power to activate
6	CH – Select AUX Video input Short press "CH" to switch between the video inputs and full or split viewing mode. Dual input > VIDEO1> VIDEO2> BACK-UP CAMERA>. Note: No parking guide lines will show when in this mode. Reverse guide lines will only show when in reverse and the camera is displayed on the screen. See remote operation for setup of guide lines. This function is locked out while in Reverse Gear.
7	*- Color Mode Adjustment Short press * to adjust Hue level of the Monitor. Four modes are available, Soft> Standard> Vibrant > Bright. This function is locked out while in Reverse Gear.



8	Mounting foot/arm-Others included in package
9	Power Harness Connector
10	Exterior Light Sensor
11	Red Wire – ACC+ Connection
12	Black Wire – GND - Connection
13	Green - Rev Trigger, Purple - Vid 1 Trigger, White - Vid 2 Trigger
14	Camera Input
15	Video 1 Input
16	Video 2 Input
17	Cable Cover
18	Harness Connector Cover

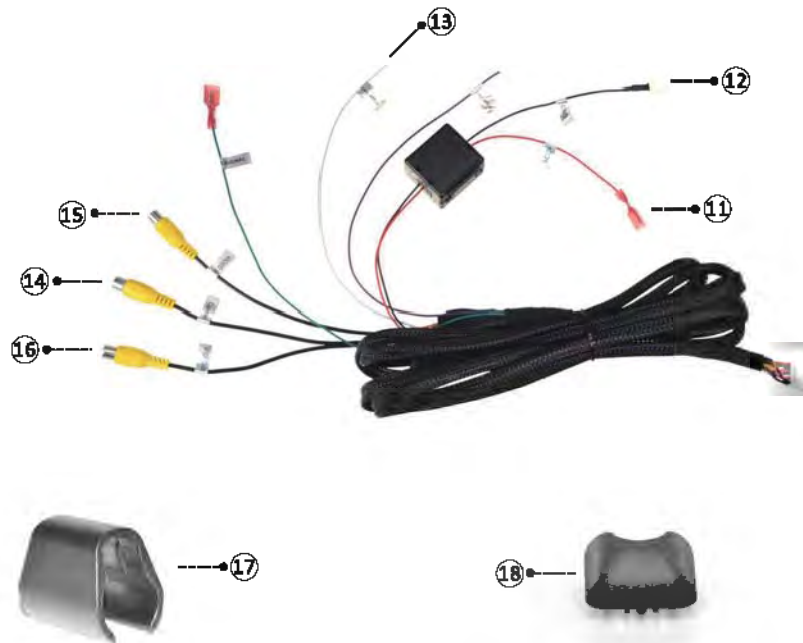

• A fuse is located in the filter box on the wire harness. Only replace with a 2 amp fuse if needed.

Chapter two: Installation and Wiring

2.1 Removing the original mirror

CAUTION: DO NOT USE EXCESSIVE FORCE WHEN REMOVING MIRROR FROM THE WINDSHIELD MOUNT. THE WINDSHIELD BUTTON MAY SEPARATE FROM THE WINDSHIELD OR THE WINDSHIELD MAY BREAK IF FORCED. NOTE: There are several versions of mirror mount systems. If unfamiliar with mirror removal, seek professional assistance.

NOTE: Always use caution, DO NOT force the mount. VOXX will not be responsible for broken windshields. If you are not sure how to remove or reinstall the mirror seek trained, qualified help.

Screw mount mirror removal.

- Using a Phillips screwdriver or #20 torx bit, loosen the screw in the base of the mirror.
- After loosening screw, gently lift upward to slide mirror off of mirror mount.

Wedge mount mirror removal procedure: (Common for screw less mount).

- Using a mirror tool or small 1/8" (4 mm) flat-blade screwdriver, insert the flat end into the opening at the bottom of the mirror mount at the windshield.
- Slide the screwdriver into the center of the mirror mount until resistance is felt.
- Gently apply a small amount of additional upward force to lift away locking spring in the mount.
- While still applying upward pressure with the screwdriver, grasp the mirror bracket and wiggle side to side. Lift mirror up toward the headliner and off the windshield mount button.

Camlock Mirror Removal procedure: (Common Method)

- Grasp the base of the mirror.
- Rotate 90 degrees left or right.
- Slide mirror downward toward dash to remove

2.2 Installation

Mirror Installation:

Installation will vary depending on the mounting foot you use for the vehicle.

The mount pre-installed on the mirror is for a standard wedge mount foot. If you need to use a different foot, change the foot by removing the Philips head screw in the center of the foot.

Attach the required foot to the mounting arm with the included screw.

Route the wire harness from the mirror, behind the headliner, and down the A Pillar post. DO NOT run the wire in front of or over airbags or other safety devices. Insure the wire harness will not be pinched or damaged when you replace the vehicle trim panels.

2.3 How to wire

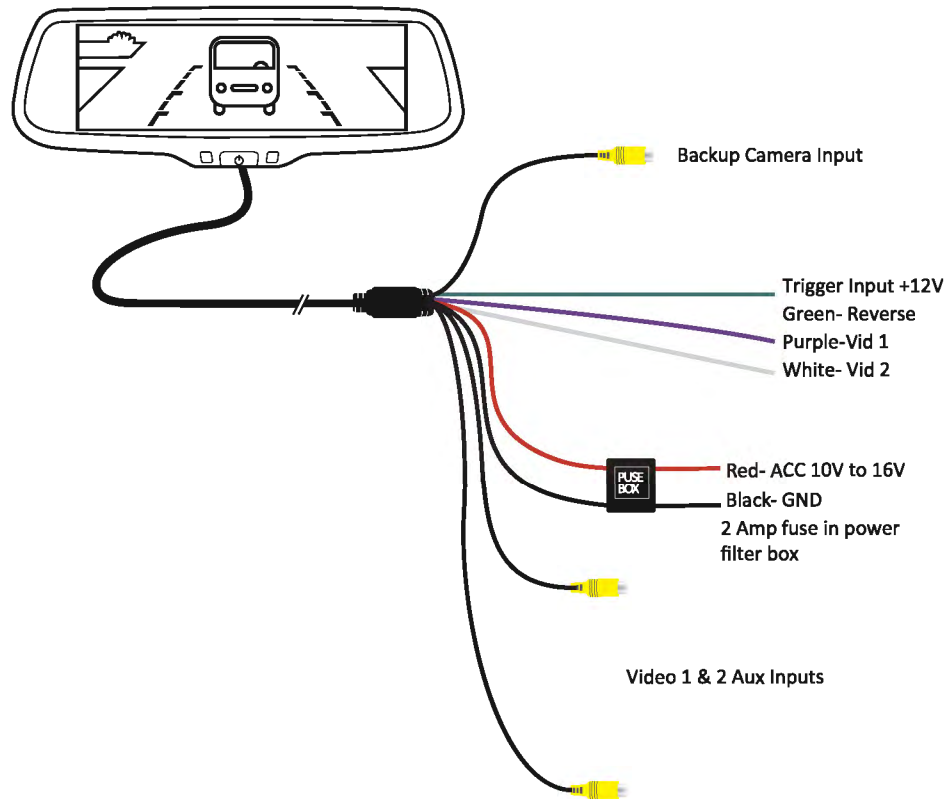

NOTE: In vehicles with LED type tail lights you may not have enough current to operate a camera or other device by drawing power from the tail lamp directly. In this case use the white tail light power as a trigger for a relay and supply power to the monitor/camera/trigger through the relay.

WIRING:

Examine the vehicle to determine the best way to run the power harness to the following:

- Accessory power
- Reverse trigger
- Camera video connection
- Aux Video Connections

Always use caution to insure you do not interfere with any airbag or other safety devices.

2.4 Display modes

Reverse Camera Operation: The monitor will automatically display the backup camera in wide screen mode whenever the vehicle is placed into Reverse gear.

NOTE: Always use your mirrors as well as look behind, right, and left as obstacles can still be hidden from view of the camera.



Split Screen Operation: The split screen can be used for Right and Left Zone / Blind spot viewing or AUX Inputs. When using for side view cameras connect the camera video signal to the input and connect the trigger wires to the turn signal lamp positive wire. When the turn signal is turned on the corresponding screen will show the video from the attached camera. To use as AUX Input do not connect the trigger wire, use the on screen controls to view the video signal.

NOTE: Reverse mode will always take priority and show over any other input when the vehicle is placed in reverse gear.



Split Screen Operation: By pressing the touch buttons on the panel you can select your AUX inputs.

Monitoring Operation: By pressing the touch screen buttons you can also monitor your rear view camera or side camera if equipped. **Note:** Your camera must be wired to constant power for this to operate correctly.

Chapter three: Adjustable Guidelines

3.1 Understanding The Guide Lines

The RVM740 is equipped with adjustable guide lines that should be set correctly at the time of installation. Generally these guidelines are used to help drivers estimate the distance from obstacles when parking.

There are three lines for reference - Red, Yellow and Green. These three lines are displayed on the monitor when car is in reverse. The lines should be adjusted so the green line starts approximately 9ft away from the rear of car, the yellow line starts approximately 6ft away from the rear of car, and the red line starts approximately 3ft away from the rear of car.

The lines should also be adjusted to be approximately 6 inches wider than the vehicle on each side to assist in parking.

3.2 Camera Position and Vehicle Width Guide Line Adjustment

In some applications the camera will be mounted Off-center. The RVM740 allows for adjustment for the position of the camera and the width of the vehicle. By adjusting the lines correctly this will insure the driver is viewing a correct representation of their vehicle while backing.



3.3 How to adjust the guide lines

Adjusting the guide lines

Adjusting the guidelines:

By placing items behind the vehicle at the measurements shown above you will be able to easily and quickly customize the parking lines for this particular vehicle.

Once you have either marked the area or place items such as traffic cone behind the vehicle make sure the parking brake is engaged and no one is behind the vehicle.

- Place the vehicle into reverse gear and press the guideline adjustment key  in the center of the 4 directional keys on the remote control.
- A series of position numbers will appear at the top of the screen. The system will always select the left line first. (XL)
- Press the button again to select the right guide line (XR).
- Use the up, down, left, and right buttons to adjust the location of the selected guideline.
- To adjust the angle of the guidelines press the rotation keys below the 4 position keys to rotate the lines clockwise  and counter clockwise .
- When you are finished place the vehicle in Park, the monitor will shut off and the positions will be saved in the RVM740's memory.

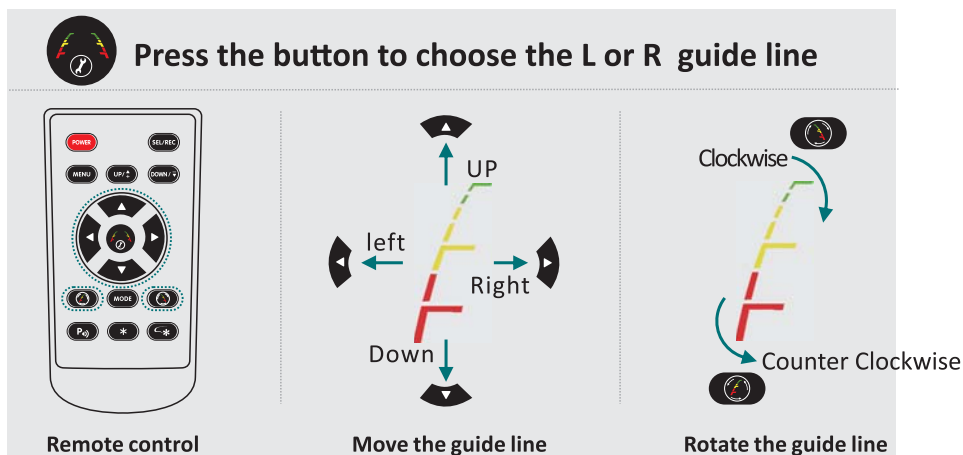

Chapter Four: Menu Settings

4.1 Remote control

The menu only can be set by remote control, and kindly check its definition as below.

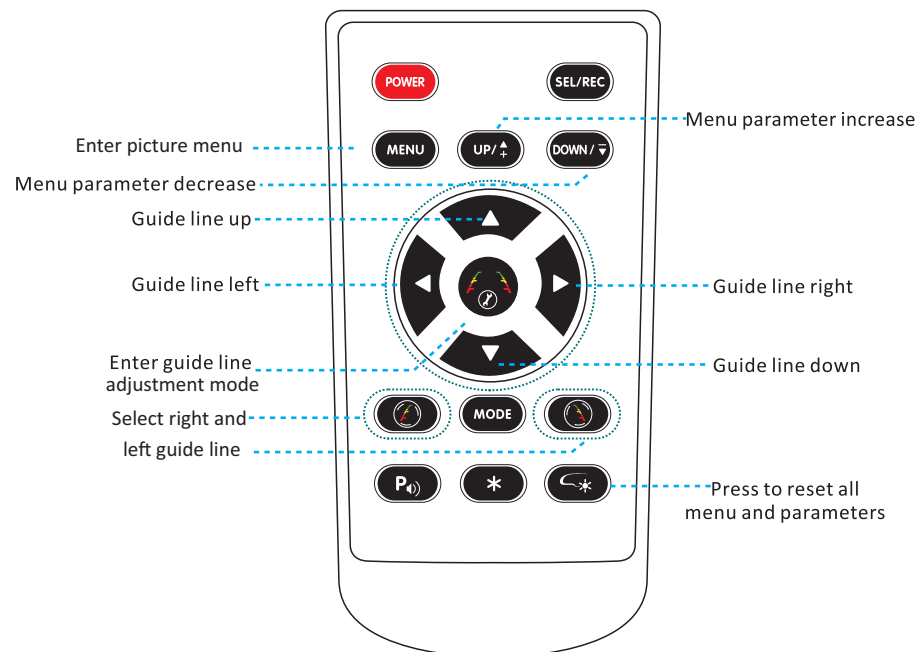

4.2 Menu settings

Short press the "MENU" button to enter the first setting which will be "BRIGHTNESS", By pressing MENU again you will scroll through the settings options "COLOR", "CONTRAST", "SCALE", "START LOGO", "PRESET", or continue to exit out of the menu. Use the UP / DOWN buttons to change the value of each screen, press menu briefly to exit that option and move to the next. Press MENU until you exit out of the settings options.

4.2.1 BRIGHTNESS

The default setting is 50, this can be adjusted from 0 to 100.



4.2.2 COLOR

The default setting is 50, this can be adjusted from 0 to 100.



4.2.3 CONTRAST

The default setting is 50, this can be adjusted from 0 to 100.



4.2.4 SCALE

Scale ON/OFF selects if the Parking Lines /Scale is visible. Use the UP/DOWN keys to select ON or OFF. Default setting is ON.



4.2.5 START LOGO

This will disable the boot screen/start up logo. Use the UP/DOWN keys to select ON or OFF. Default is ON.



4.2.6 PRESET ADJUSTMENT

The Preset option will return your screen to the factory default settings. Select ON to reset all settings. The option will automatically return to OFF after the reset is complete.



When in reverse and the camera is being shown all other functions are blocked. You can adjust the brightness up by briefly pressing the power button; also a long press will shut off the reverse image if needed. To restore the image press the button again or it will display again next time the vehicle is placed into reverse gear.

Limited Warranty

DO NOT RETURN THIS PRODUCT TO THE STORE

Voxx Electronics Corporation (“the Company”) is committed to quality and customer service, and are pleased to offer you this Warranty. Please read it thoroughly and contact the Company at 1-800-323-4815 with any questions.

Who is covered?

The Company extends this warranty to the original retail purchaser of products purchased through an authorized Voxx retailer in the U.S.A., Puerto Rico or Canada. This warranty is not transferable or assignable. Proof of purchase is required in the form of an original sales receipt.

What is covered?

The Company warrants that should this product or any part thereof, under normal use, be proven defective in material or workmanship within 36 months from the date of original purchase, such defect(s) will be repaired or replaced with a new or reconditioned product (at the Company’s option) without charge for parts and repair labor.

What is not covered?

This Warranty *does not* cover the following:

- Damage incurred during shipping or transporting the product to the Company or a service center
- Elimination of car static or motor noise
- Defects in cosmetic, decorative or non-operative structural parts
- Correction of antenna problems
- Costs incurred for installation, removal or reinstallation of the product
- Consequential damage to compact discs, USB devices, digital media cards, accessories or vehicle electrical systems
- Damage caused by improper installation, mishandling, misuse, neglect, accident, blown fuse, battery leakage, theft or improper storage
- Products whose factory serial number/bar code label(s) or markings have been removed or defaced
- Damage resulting from moisture, humidity, excessive temperature, extreme environmental conditions or external natural causes

Please review the “Care and Maintenance” section of your Installation and Operation Manual for additional information regarding the proper use of your product.

Limitations

THE EXTENT OF THE COMPANY’S LIABILITY UNDER THIS WARRANTY IS LIMITED TO THE REPAIR OR REPLACEMENT PROVIDED ABOVE AND, IN NO EVENT, SHALL THE COMPANY’S LIABILITY EXCEED THE PURCHASE PRICE PAID BY PURCHASER FOR THE PRODUCT.

This Warranty is in lieu of all other express warranties or liabilities. ANY IMPLIED WARRANTIES, INCLUDING ANY IMPLIED WARRANTY OF MERCHANTABILITY, SHALL BE LIMITED TO THE DURATION OF THIS WRITTEN WARRANTY. ANY ACTION FOR BREACH OF ANY WARRANTY HEREUNDER INCLUDING ANY IMPLIED WARRANTY OF MERCHANTABILITY MUST BE BROUGHT WITHIN A PERIOD OF 24 MONTHS FROM DATE OF ORIGINAL PURCHASE. IN NO CASE SHALL THE COMPANY BE LIABLE FOR ANY CONSEQUENTIAL OR INCIDENTAL DAMAGES FOR BREACH OF THIS OR ANY OTHER WARRANTY, EXPRESS OR IMPLIED, WHATSOEVER. No person or representative is authorized to assume for the Company any liability other than expressed herein in connection with the sale of this product.

Some states do not allow limitations on how long an implied warranty lasts or the exclusion or limitation of incidental or consequential damage so the above limitations or exclusions may not apply to you. This Warranty gives you specific legal rights and you may also have other rights which vary from state to state.

Obtaining Warranty Service

- To obtain repair or replacement within the terms of this Warranty, call 1-800-323-4815 for the location of a warranty station serving your area.
- You must prepay the initial shipping charges to the Company. The Company will pay the return shipping charges for all warranted products returned to an address within the U.S.A., Puerto Rico or Canada.
- Please package the product securely to avoid shipping damage. We recommend using a carrier that provides tracking service to prevent lost packages. Lost or damaged packages are not covered by this warranty.
- Provide a detailed description of the problem(s) for which you require service.