

ADVXL10 A
10.1" OVERHEAD LED BACKLIT
LCD MONITOR WITH
DVD PLAYER

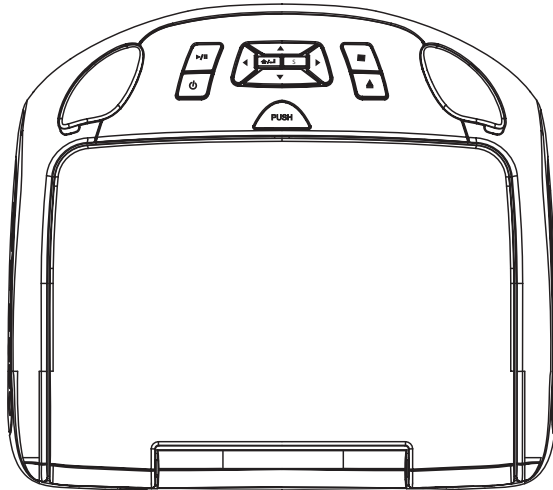

ADVENT®

OWNER'S
MANUAL

HDMI®
HIGH-DEFINITION MULTIMEDIA INTERFACE

MHL™
Mobile High-Definition Link

TABLE OF CONTENTS

FCC Statement	3	TV TYPE	22
Important Notice	4	PASSWORD	23
Warnings	4	DDFAULT-RESTORE	23
Congratulations	5	LANGUAGE SETUP	24
Safety Precaution	5	OSD LANGUAGE	24
Features	5	AUDIO LANG	24
Controls and Indicators Diagram (Front View).....	6	SUBTITLE LANG	24
Controls and Indicators Diagram (Side Views).....	7	PLAYING DEVICES	25
Remote Control Operation	8	PLAYING USB MEMORY DEVICES	25
Remote Control Functions	8	Playing MP3 Discs	26
Turning the Unit On or Off	13	Selecting of Audio/Photo/Video mode.....	26
Source Menu	14	DVD BASICS	27
System Menu Settings and Adjustments	16	Overhead Dome Lights	28
Picture (Control).....	16	Accessories	29
WFMM (FM Modulator)	17	Wireless Headphones	29
Settings	18	Wireless Game Package (MVG P1).....	29
Default DVD.....	18	HDMI/MHL and USB Port Information.....	30
Screen Mode	18	HDMI1	30
Monitor Mode.....	19	Smartphones and Tablets.....	30
IR Transmitter.....	20	USB Port	30
Language	20	Troubleshooting	31
Factory Setting.....	20	Replacement Parts	33
SETTINGS AND ADJUSTMENTS	21	Specifications.....	33
Using the Setup Menu.....	21	Warranty	34
SYSTEM Setup.....	21	Notes	35
TV SYSTEM	21		
SCREEN SAVER	22		

FCC Statement

This device complies with Part 15 of the FCC Rules. Operation is subject to the following two conditions: (1) This device may not cause harmful interference, and (2) this device must accept any interference received, including interference that may cause undesired operation. This equipment has been tested and found to comply with the limits for a Class B digital device, pursuant to Part 15 of the FCC Rules. These limits are designed to provide reasonable protection against harmful interference in a residential installation.

-Reorient or relocate the receiving antenna.

- Increase the separation between the equipment and receiver.

- Connect the equipment into an outlet on a circuit different from that to which the receiver is connected.

- Consult the dealer or an experienced radio/TV technician for help.

FCC Caution: Any change or modifications not expressly approved by the party responsible for compliance could void the user's authority to operate this equipment.

Radiation Exposure Statement

This equipment complies with FCC radiation limits set forth for an uncontrolled environment. This equipment should be installed and operated with minimum distance 4.5in (20cm) between the radiator & your body.

Important Notice

Installation of overhead products requires careful planning and preparation. Be extremely careful when working on a vehicle with side curtain air bags. Do not route wires near any portion of the side curtain air bag assemblies. This includes any anchor points in A, B, C or D pillars of the vehicle. Routing wires in these areas or running wires by the side curtain air bags can prevent the side curtain air bag from fully deploying which can result in personal injury to vehicle occupants. If you have any questions regarding wire routing in a vehicle, please contact Audiovox Technical Support at 1-800-225-6074.

When connecting power and ground in a mobile video installation ensure that the ACC wire is fused at the point where it is connected to the vehicle ACC wiring. Failure to do so can result in damage to the vehicle if a short circuit develops between the vehicle connection point and the mobile video product.

An LCD panel and/or video monitor may be installed in a motor vehicle and visible to the driver if the LCD panel or video monitor is used for vehicle information, system control, rear or side observation or navigation. If the LCD panel or video monitor is used for television reception, video or DVD play, the LCD panel or video monitor must be installed so that these features will only function when the vehicle is in "park" or when the vehicle's parking brake is applied.

An LCD panel or video monitor used for television reception, video or DVD play that operates when the vehicle is in gear or when the parking brake is not applied must be installed to the rear of the driver's seat where it will not be visible, directly or indirectly, to the operator of the motor vehicle.

Warnings

- Do not use any solvents or cleaning materials when cleaning the video monitor.
- Do not use any abrasive cleaners, they may scratch the screen.
- Use only a lightly dampened lint free cloth to wipe the screen if it is dirty.
- Lock the LCD screen in the fully closed position when not in use.
- Before putting on headphones always adjust the volume setting to the lowest position.
- Remember to leave the dome light switch in the off or auto positions when the vehicle is unattended, as the dome lights, if left on, can drain the vehicle's battery.
- Do not put pressure on the screen.
- Caution children to avoid touching or scratching the screen, as it may become dirty or damaged.

Patented: Refer to www.voxxintl.com/company/patents

Congratulations

Congratulations on your purchase of the ADVENT ADVEXL10 A DVD Player with drop-down video / monitor. The ADVEXL10 A has been designed to give you and your family many years of video entertainment in the mobile environment. Please read the directions that follow to familiarize yourself with the product to ensure that you obtain the best results from your equipment.

Note: Installation options vary, see the individual owner's manuals for each component in your system to obtain a full understanding of each component's operation.

Safety Precaution

For safety reasons, when changing video media, it is recommended that the vehicle is not in motion, and that you do not allow children to unfasten seat belts to change video media or make any adjustments to the system. System adjustments can be accomplished using the remote control, while seat belts remain fastened. Enjoy your ADVENT entertainment system but remember the safety of all passengers remains the number one priority.

FEATURES

- 10.1" TFT (Thin Film Transistor) Active Matrix LCD (Liquid Crystal Display) Monitor
- LED Backlighting
- Built-in DVD Player
- Auto-On With Disc Insertion
- HDMI / MHL Inputs
- OSD (On Screen Display) for Control of Picture Quality and Functions
- Selectable (M1 and M2) IR Receive and Transmit Codes (See page 9)
- Switchable Dual Channel IR Infrared Transmitter (See page 19)
- Nine Source Input*
(DVD, USB, HDMI 1, HDMI 2, Media, AV, AUX, DTV, Game)
*Note: The DTV and Game modules are optional equipment and can be purchased separately.
- Dome Lights with Built-in Three Way Switch
- Built-in 100 Channel Wireless FM Modulator
- Last Position Memory for DVD
- Screen Mode Selection (4:3, 16:9)
- Full Function Remote Control
- Backlit Controls
- AV Output via RCA Jacks
- Plays DVD, CD and MP3 Discs
- Game Port Ready
- Mobile DTV Ready

CONTROLS AND INDICATORS DIAGRAM (FRONT VIEW)

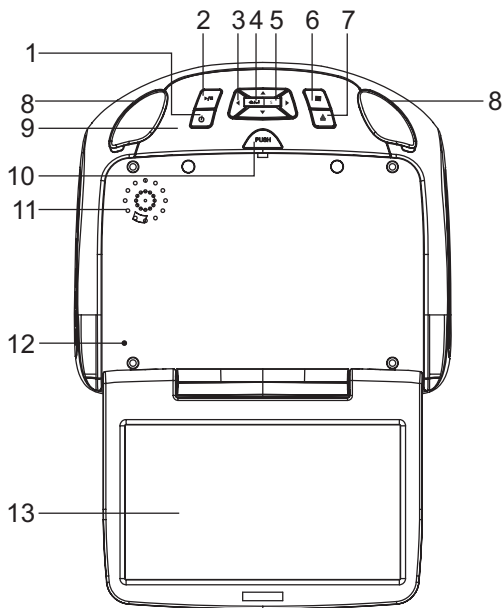

1. POWER (⏻) Button

This button is used to turn the system on/off.

2. Play/Pause (▶/⏸) Button

This button is used to start playback of a disc or pause a disc.

3. UP / DOWN / LEFT / RIGHT (▲▼◀▶) Cursor Buttons

These cursor buttons are used to navigate menu selections on the screen.

4. HOME/MENU Select Button

This button is used to display and select options on the system menu. Press and hold for 3 seconds to access the System Menu.

5. Source/Select (S) Button

Press this button to display the Source OSD screen. Use the cursor buttons to highlight the desired source. Press the Source/Select button to access the desired source.

6. STOP (■) Button

-Press the STOP button once: Stops playback.
-Pressing the PLAY button again will resume normal playback from where movie was stopped.
-Press the STOP button twice and then press the PLAY button to start playback from the beginning of the DVD.

7. EJECT (▲) Button

This button is used for ejecting a disc from the disc compartment.

8. Dome Lights

Provide additional interior illumination.

9. Infrared Transmitter/Remote Sensor

(Location)

10. Screen Release

Push this button to release the screen from the locked position.

11. Ventilation Openings

12. LCD Cut Off Switch

Used to turn off the LCD backlight when the LCD is in the closed position.

13. LCD Panel

CONTROLS AND INDICATORS DIAGRAM (SIDE VIEWS)

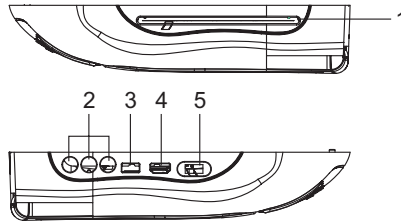

1. DVD Disc Insertion Slot

For loading and removing discs. When a disc is inserted, the unit will automatically turn ON and switch to DVD source. Insert a disc with label side facing up.

Note: The disc slot indicator is red when a disc is inserted and green when the disc slot is empty.

2. AUX IN

These jacks are used to supply external audio and video inputs to the unit. (Yellow - Video, White - Left Audio, Red - Right Audio).

3. USB INPUT

For connection of a USB memory device. This input will also charge a USB device that contains a battery. See page 30 for more information.

Note: The USB input supplies up to 1 Amp of charging current. Devices such as tablets may require more than 1 Amp of charging current and it is recommended to connect the device to a vehicle power outlet for full charging capabilities. When the unit is in DVD/USB mode, 1 Amp charging is not available.

4. HDMI/MHL 1 INPUT

For connection of devices with HDMI/MHL outputs. See page 30 for more information.

Note: Requires a HDMI/MHL enabled device and a special HDMI/MHL adapter. Contact your HDMI/MHL device supplier for the adapter.

5. THREE POSITION DOME LIGHT SWITCH

ON - Turns on the dome lights.

OFF - The dome lights will not turn on in this position.

AUTO - Automatically turns on the dome lights in conjunction with the vehicle's interior illumination.

REMOTE CONTROL OPERATION

Initial Use

When purchased, the remote control has a battery installed with a Pull Tab to prevent battery discharge. Remove the Pull Tab before attempting to use the remote control.

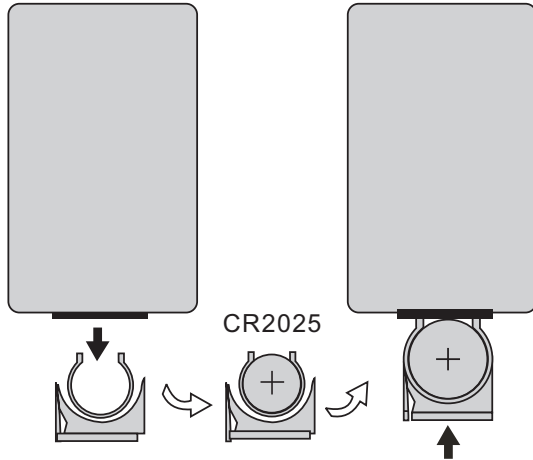

Battery Replacement

1. Remove the battery holder.
2. Insert one CR2025 battery into the battery holder. Be sure to observe the correct polarity.
3. Align the battery holder with the remote control and insert. Push it in until the holder clicks.

REMOTE CONTROL FUNCTIONS

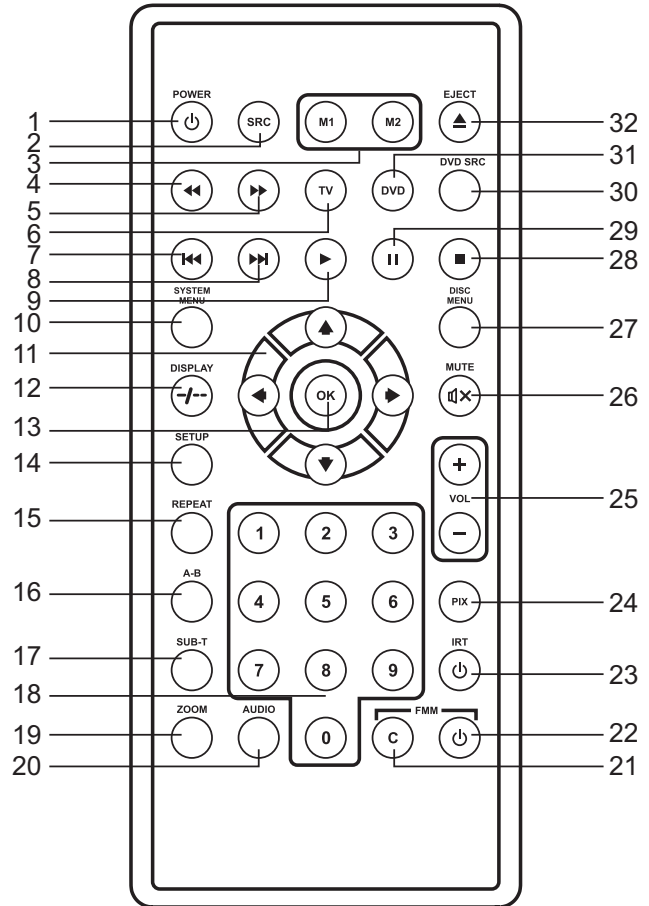

* Function control is available on the unit and the Remote Control.

** Function not available in this model.

1. POWER*

Press this button to turn the unit ON and OFF.

2. SOURCE*

Press to display the Source OSD for DVD, USB, HDMI 1, HDMI 2, Media, AV, AUX, DTV and Game.

3. MONITOR SELECT

M1 Button – Set the remote control code to allow control of the unit in M1 mode.

M2 Button – Set the remote control code to allow control of the unit in M2 mode.

4. SCAN BACKWARD (◀◀)

Press to search in a backward direction. Press repeatedly to change the search speed from 2, 4, 8, 16 times and normal speed.

5. SCAN FORWARD (▶▶)

Press to search in a forward direction. Press repeatedly to change the search speed from 2, 4, 8, 16 times and normal speed.

6. TV Mode Select

Switches certain function keys on the remote control for monitor functions.

7. PREVIOUS (◀◀)

Press to return to the previous chapter or track.

8. NEXT (▶▶)

Press to skip to the next chapter or track.

9. PLAY (▶)*

Press to activate the play mode while a disc is loaded into the disc compartment.

10. SYSTEM MENU

Allows the user to access the system menu. Press the ◀ or ▶ cursor buttons to select PICTURE, WFMM (FM Modulator) and SETTING.

11. CURSOR (▲▼◀▶)

Use the cursor buttons to access menu selections on the screen.

12. DISPLAY

Press once to display current disc information of Title, Chapter & Time. Press again to display Subtitle, Audio & Angle while the disc is playing. Press and hold 3 to 4 seconds on the display key to enter the edit mode, press cursor(◀▶) buttons to edit the Title, Chapter, & Time.

13. OK

Used to execute a selected setting or menu option.

14. SETUP

Allows the user to access the Setup Menu when the unit is in DVD mode. Use the ▲▼◀▶ cursor buttons to select options such as language, video, rating, Misc.

15. REPEAT

Allows the user to repeat a selected title, chapter, or track.

16. A-B REPEAT

Allows user to repeat the playback from point A to point B.

Press A-B button

On-Screen Display

DVD player

Once

Repeat A

Mark the beginning of the section to repeat (Set point A)

Twice

A-B

Mark the end of the section to repeat (Set point B)

3 times

AB Off

Cancel the A-B repeat function

17. SUBTITLE

Press to display and select the subtitle language in DVD mode. Each time this button is pressed, the subtitle language changes.

Note: The type and number of languages for subtitles vary from disc to disc.

18. NUMBERS

Allows the user to enter the numbers 0-9 for selection of the tracks, titles, chapters or password setting.

19. ZOOM

Press this button to enlarge the picture when playing a DVD disc. Press repeatedly to change the zoom from Zoom 2, Zoom 3, Zoom 4, Zoom 1/2, Zoom 1/3, Zoom 1/4, and Zoom OFF.

2 → 3 → 4 → 1/2 → 1/3 → 1/4 → off

20. AUDIO

Press to display and select audio language in DVD mode. Each time this button is pressed, the language changes.

Note: The available languages vary from disc to disc.

21. FM MODULATOR CHANNEL SELECT (C)

The unit has a 100 channel built-in wireless FM Modulator. The FM Modulator can be set from 88.1 MHz to 107.9 MHz in 0.2 MHz steps, i.e. 88.1, 88.3, 88.5, 88.9, 90.1 etc. Pressing the **C** button will display the FM Modulator frequency setting OSD. Use the cursor buttons to select the frequency. Refer to the SYSTEM MENU SETTINGS AND ADJUSTMENTS for more details.

22. FMM ON/OFF

Turns the FM Modulator power on/off.

23. IRT ON/OFF

Turns the Infrared Transmitter on/off for IR wireless headphones.

24. PIX (Picture Select)**

No function on this model.

25. VOLUME DOWN (-) or UP (+)**

No function on this model.

26. MUTE

Press this button to mute the audio for the wireless FM Modulator, IR headphones and audio output.

Pressing the button again restores the audio to the previously set level.

27. DISC MENU

In DVD mode, press once to access the Root Menu and then press again to resume to previous screen. For MP3 or photo view mode, press once to return to Audio/Photo/Video option menu.

Note: Press and hold 3 to 4 seconds to view in small icon in photo display. Long press hold only active in photo view mode.

28. STOP (■)*

Press to stop playback. (Playback will resume from the point it is stopped).

Press twice to stop playback fully. (Playback will resume from the beginning of the disc).

29. PAUSE (II)*

Press to pause playback.

30. DVD Source**

No function on this model.

31. DVD Mode Select Button

Switches certain function keys on the remote control for DVD function.

32. EJECT (▲)*

Press this button to eject the disc.

TURNING THE UNIT ON OR OFF

1. Push in the Screen Release button to unlock the LCD screen. The screen will drop down slightly.
2. Pivot the screen downward until a comfortable viewing angle is reached. The hinge friction will hold the screen in position while the system is in use.
3. Press the power button on the unit or the remote control to turn the system on and off. When in use, the internal backlighting will illuminate the controls.
4. After the unit has been turned on and is displaying a picture, adjust the viewing angle by pivoting the screen to optimize the picture quality.
5. Remember to turn the unit off and pivot the LCD screen to the locked position when not in use.

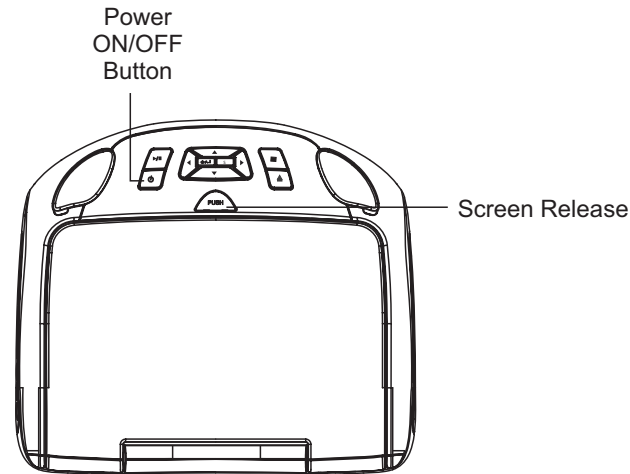

SOURCE MENU

The ADVEXL10 A System is capable of accessing nine source inputs. To select or change a source, press the source, S, button on the front panel or the SRC button on the remote control. The source OSD will appear on the screen as shown in the figure below. Use the ▲ ▼ ◀ or ▶ cursor buttons on the front panel or the ▲ ▼ ◀ or ▶ cursor buttons on the remote control to highlight a source. Press the Source, S, button on the front panel or the OK button on the remote control to select the desired source.

Note: If a source is grayed out, that source is not available or not installed such as DTV or Game.



DVD

The DVD source input is used to play DVDs, Audio CDs and MP3 discs.

USB

The USB source input is used to play MP3 files, JPEG files (Photos) and MPEG I, II files. See page 30 for more information.

HDMI 1 & HDMI 2

The HDMI inputs allow the user to enjoy high-definition digital images and high-quality sound by connecting a HD device such as a Blu-ray player or smartphone with an HDMI output to the system. The HDMI inputs also allow the user to connect with a Mobile High-Definition Link (MHL) mobile phone. Plug in the HDMI/MHL device with a special adapter available from your mobile phone provider. See page 30 for more information.

Notes:

- This source requires an HDMI/MHL enabled device and a special HDMI/MHL adapter. Contact your HDMI/MHL device supplier for the adapter.
- Phone functionality (phone calls, texting, etc.) may be limited while using the adapter.
- HDMI content is copy protected and is not available on the AV output of the ADVEXL10 A System.

APPLICABLE HDMI FEATURE

- Input audio signal: 2 channel.
- Input video signal: 480p, 576p, 720p, 1080i, and 1080p.

Note: MHL is only available on HDMI1.

MEDIA

The Media source allows for the user to connect an Apple device (e.g. iPod, iPhone, iPad) to the ADVEXL10 A System to play audio and video content. A special Apple adapter is required for this connection. See your Apple or electronics dealer for the specific adapter required. Connect the adapter to the Apple device, and connect the Audio, Video, and USB connectors into the ADVEXL10 A System. With the Media source selected, the desired video and audio content can be displayed on the ADVEXL10 A System.

Notes:

- The USB input supplies up to 1 Amp of charging current. Devices such as tablets may require more than 1 Amp of charging current and it is recommended to connect the device to a vehicle power outlet for full charging capabilities.
- The Apple device will not display the desired audio and video content on the Apple device screen. The desired audio and video content will only be displayed on the ADVEXL10 A System.

AV

An external video source, video game system, or other audio/video devices can be connected to the AV input. This AV input connection is normally performed when the unit is installed. Turn the video source component on with its power button or remote control and it is now ready to play the audio and video signals from the source connected to the AV input.

Note: If a DTV module is installed, this input will not be available and the AV source will be grayed out.

AUX

An external video source, video game system or other audio/video devices may be connected to the system via the AUX input. Plug the RCA plugs from the external source into the RCA jacks on the side of the unit. Turn the external source component on with its power button or remote control and it is now ready to play the audio and video signal from the source connected to AUX.

DTV

The optional DTV (Digital TV) input is used for a digital TV module. If the digital TV module is not installed, the DTV Source will be grayed out on the source selection screen and cannot be selected. Check with your installer for availability.

GAME

The optional MVGP1 Wireless Game Package consists of 2 game controllers and a game module containing 54 games, 6 of which are two player games. If the MVGP1 Wireless Game Package is not installed, the Game Source will be grayed out on the source selection screen and cannot be selected. Check with your installer for availability.

SYSTEM MENU SETTINGS AND ADJUSTMENTS

The System Menu contains features and options that let the user customize the system. For example, the user can change the Picture, FM Modulator, OSD language, source default, screen mode display, and the monitor mode.

Using the System Menu

1. Press the SYSTEM MENU button on the remote control. The system menu main page will appear on the screen.
2. Use the ▲ ▼ ◀ or ▶ cursor buttons to select an item in the sub menu, then press OK to select.
3. Press the System Menu button to exit the System Menu.

Note: The System Menu can be controlled via Remote Control or the Home button on the front panel of the unit (Items selected in the menu will have a yellow background).

PICTURE (CONTROL)

When watching a program, the picture quality can be adjusted to the user's preferences.

1. Press the System Menu button on the remote control (or press and hold the Home/System menu button on the front panel for 3 seconds) and the Picture Control Menu will be displayed. The menu contains the on screen picture "adjustment bar" for BRIGHTNESS, CONTRAST, COLOR, TINT (for NTSC only) or RESET.

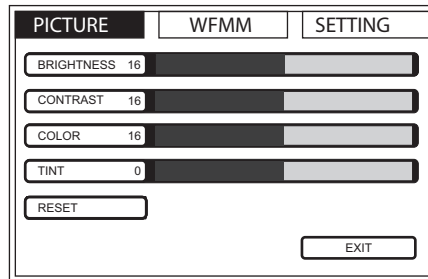

2. Use the ▲ ▼ ◀ or ▶ cursor buttons on the remote control or the front panel to adjust the selected adjustment bar for picture quality.

Note: The System Menu will time out after 5 seconds if no buttons are pressed.

WFMM (FM MODULATOR)

The FM Modulator allows the user to listen to audio through the vehicle's radio.

ON - Turns the wireless FM Modulator on if audio playback through your vehicle's radio is preferred.

OFF - Turns the wireless FM Modulator off.

FREQUENCY - Allows the user to select the wireless FM Modulator frequency. The unit has a 100 channel built-in wireless FM Modulator. The FM Modulator can be set from 88.1 MHz to 107.9 MHz in 0.2 MHz steps, i.e. 88.1, 88.3, 88.5, 88.9, 90.1 etc.

PICTURE	WFMM	SETTING	
ON	OFF		
FREQUENCY			
88.10	88.30	88.50	88.70
88.90	89.10	89.30	89.50
89.70	89.90	90.10	90.30
90.50	90.70	90.90	91.10
91.30	91.50	91.70	91.90
◀		▶	
EXIT			

To choose an FM frequency for audio playback through your vehicle's radio:

1. Press the SYSTEM MENU button to access the System Menu. The System Menu screens appears.
2. Use the ▶ cursor button to highlight wireless FM modulator (WFMM).
3. Use the ▼ cursor button to highlight the FREQUENCY Submenu.
4. Use the ▲ ▼ ◀ or ▶ cursor buttons to select a frequency not used by a radio station in the area. Press OK to select the highlighted frequency.
There are a total of 5 FM CHANNEL pages containing frequencies from 88.1 MHz to 107.9 MHz in 0.2 MHz steps. To access the additional FM Channel pages, use the ◀ or ▶ cursor buttons to highlight the on screen left and right arrows and press OK. Once the frequency has been selected, tune the vehicle's radio to the selected frequency.
5. Press the DVD button to restore the remote control to DVD functions.

Note: The wireless FM modulator will perform well in most applications. However, in certain geographical areas the quality of the wireless signal may be less than optimal, resulting in static or strong local station bleed through. If this is a consistent problem, an FMDIRB (hard wired FM connection) can be installed by your dealer.

SETTINGS

DEFAULT DVD

This allows the user to set the system default source to DVD on or off. If source default is set to ON, every time the unit is turned off then on, the unit will power up and automatically switch the source to DVD. If source default is set to OFF and the unit is turned off then on, the unit will power up in the source that was last selected.

1. Press the System Menu button.
2. Use the ► cursor button to highlight SETTING.
3. Use the ▼ cursor buttons to highlight DEFAULT DVD.
4. Use the ◀ or ▶ cursor buttons to select ON or OFF.
5. Press OK to confirm the setting.

Note: The unit is set to source default DVD on as the default mode of operation. Selection of Source default can only be made from within the system menu.

SCREEN MODE

This allows the user to change the screen format (aspect ratio 16:9, 4:3). To select the screen aspect ratio format:

1. Press the System Menu button.
2. Use the ► cursor button to highlight SETTING.
3. Use the ▼ cursor buttons to highlight SCREEN MODE.
4. Use the ◀ or ▶ cursor buttons to select 16:9, 4:3.
5. Press OK to confirm the setting.

Note: If the screen mode is set to 4:3, the unit it will default to 16:9 when power is cycled. HDMI 1, 2 and MHL can not be switched to 4:3 screen mode.

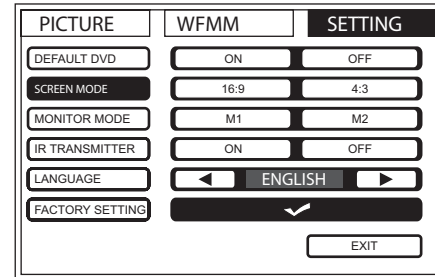
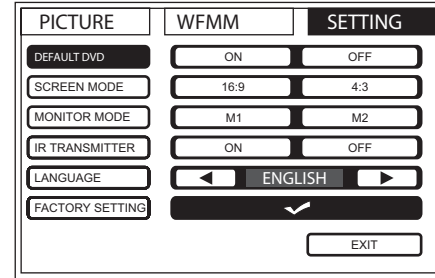

MONITOR MODE

MONITOR MODE SETTINGS

The ADVEXL10 A System has an option that allows the user to select from two IR transmit and receive codes (M1 or M2). This feature can be used when using two ADVEXL10 A systems in the same installation or if the vehicle has RSA (Rear Seat Audio) that uses an "A" channel headset. The ADVEXL10 A system comes factory set to M1. When in the M1 mode, the unit will respond to remote commands when M1 is selected on the remote control and will transmit audio on the A channel. When in the M2 mode, the unit will respond to remote commands when M2 is selected on the remote control and will transmit audio on the B channel.

Note: Use 2-channel IR headphones set to CH B when the monitor is set to M2 mode.

Selecting a Monitor Mode (M1 or M2)

1. Power ON the unit and wait until M1 or M2 appears on the OSD. M1 or M2 will appear on the screen for 4 ~ 5 seconds.
2. Press the System Menu button on the remote control to display the System Menu to change the monitor code from M1 to M2.

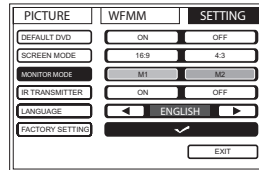

3. Use the ◀ or ▶ cursor buttons to select the Setting sub menu.
4. Use the ▲ or ▼ cursor buttons to select the Monitor Mode sub menu.
5. Use the ◀ or ▶ cursor buttons to select the desired Monitor Mode (M1 or M2).
6. Press OK to confirm the setting. The following screen will appear.

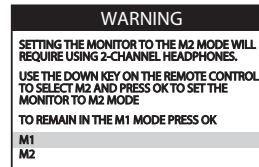

7. Use the ▲ or ▼ cursor buttons to select Monitor Mode (M1 or M2).
8. Press OK to confirm the setting.
9. Press the System Menu button on the remote control to exit the System Menu Mode.

Note: If no action is taken, this menu will disappear in 10 seconds.

IR TRANSMITTER

This allows the user to turn the IR Transmitter ON or OFF. The IR Transmitter must be set to ON for the wireless headphones to be operational.

1. Press the System Menu button.
2. Use the ► cursor button to highlight SETTING.
3. Use the ▼ cursor button to highlight IR TRANSMITTER.
4. Use the ◀ or ▶ cursor buttons to select ON or OFF.
5. Press OK to confirm the setting.

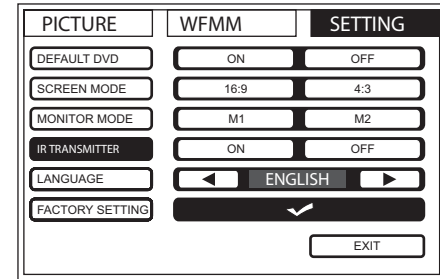

LANGUAGE

This allows the user to return the on-screen display language. The user can select English, Spanish, French, or German for the on-screen display language.

To select the screen aspect ratio format:

1. Press the System Menu button.
2. Use the ► cursor button to highlight SETTING.
3. Use the ▼ cursor button to highlight LANGUAGE.
4. Use the ◀ or ▶ cursor buttons to select the desired language.
5. Press OK to confirm the setting.

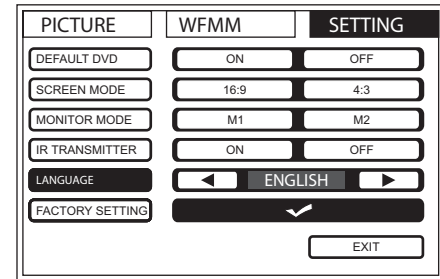

FACTORY SETTING

This allows the user to return the system to the factory default settings.

1. Press the System Menu button.
2. Use the ► cursor button to highlight SETTING.
3. Use the ▼ cursor button to highlight FACTORY SETTING.
4. Press OK to confirm the setting.

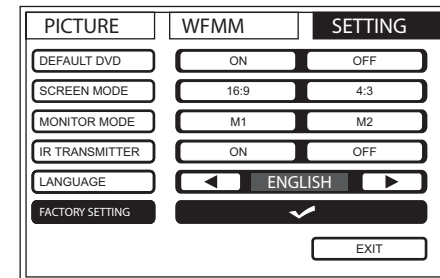

SETTINGS AND ADJUSTMENTS

The Setup Menu contains features and options that let you customize your DVD player. For example, you can set screen display or a language for the on-screen display or prevent DVD playback of certain DVD discs (for example PG-13 or R Rated) for children.

Using the Setup Menu

1. Press the SETUP button on the remote. The Setup Menu appears on the screen as shown in the illustration. There are 2 icons on the part of the Setup Menu. Each icon represents a page for

 SYSTEM SETUP

 LANGUAGE SETUP

2. Highlight the desired option using the cursor button ▲ or ▼.
3. Press ► to open the sub menu that contains the different options available. Press ▲ or ▼ to highlight the desired option, and press ENTER to confirm the selection.
4. Repeat steps 2~3 to set the options that reside on the same Setup Page.
5. To change to another Setup page, press ◀ to position the highlight back on the icon side of the setup page. Then, repeat steps 2~5.

SYSTEM SETUP

TV SYSTEM



The TV SYSTEM setup allows the user to select television standard which corresponds to your TV.

NTSC - Select this type for NTSC TV

PAL - Select this type for PAL TV

AUTO - Select this type if the connected screen is multi-system.

The output format of video signal will be in accordance with the video signal of the disc.

SYSTEM SETUP	
	TV SYSTEM
	SCREEN SAVER
	TV TYPE
	PASSWORD
	RATING
	DEFAULT
	NTSC
	PAL
	AUTO

SETTINGS AND ADJUSTMENTS(CONTINUED)

SCREEN SAVER

This option allows the operator to set the Screen Saver mode.

ON -Screen saver will appear

OFF -Screen saver will not appear

Note: The DVD player will enter Screen Saver mode if the unit is inactive for approximately 2 Minutes

SYSTEM SETUP	
TV SYSTEM	
SCREEN SAVER	ON
TV TYPE	OFF
PASSWORD	
RATING	
DEFAULT	

TV TYPE

The TV TYPE setup allows you to set the screen aspect ratio.

4:3 PS(Pan Scan)



The left and right sides of the screen are cut off and the central portion of the 16:9 screen is displayed.

4:3 LB (Letter Box)

Displays the content of the DVD title in 16:9 aspect ratio. The black bars will appear at the top and bottom of the screen.

16:9

This displays a wide picture with black bands on the upper and lower portion of the screen. The bandwidth will vary, depending on the aspect ratio of the disc

SYSTEM SETUP	
TV SYSTEM	
SCREEN SAVER	
TV TYPE	4:3PS 
PASSWORD	4:3LB 
RATING	16:9 
DEFAULT	

SETTINGS AND ADJUSTMENTS(CONTINUED)

PASSWORD

The Default Password is 3308. This password is always accepted even after a new password has been entered. To avoid the possibility of others using the default password to set the parental level and change the password, record this default password in another area and delete it from this manual.

The restriction of viewing disc content by younger users may be available on some disc but not on others.

Rating

This item allows you to limit the content of movie playback from G to Adult. The lower the value, the more strict the control.

1. G
2. PG
3. PG 13
4. R
5. NC – 17
6. Adult

For the first time setting the parental control rating, key in the default password (3308) and press ENTER to unlock the parental control rating. Press the cursor ► button to move the highlight to the parental level sub menu. Press ▲ or ▼ to select the desired level of parental control and press ENTER.

To change the password to your own password, select the Password setting and press ENTER and Key in a new four digit password, press ENTER to lock the parental control rating setting.

Note: The rating level can only be changed when the correct password is entered on the password setting.

DEFAULT - RESTORE

The DEFAULT - RESTORE allows you to restore all options to factory settings.

Note : This function will not affect the rating control settings.

SYSTEM SETUP	
TV SYSTEM	
SCREEN SAVER	
TV TYPE	
PASSWORD	-----
RATING	
DEFAULT	

SYSTEM SETUP	
TV SYSTEM	
SCREEN SAVER	
TV TYPE	
PASSWORD	XXXX
RATING	
DEFAULT	

SYSTEM SETUP	
TV SYSTEM	
SCREEN SAVER	
TV TYPE	G
PASSWORD	PG PG13
RATING	R NC-17
DEFAULT	ADULT

SYSTEM SETUP	
TV SYSTEM	
SCREEN SAVER	
TV TYPE	
PASSWORD	
RATING	
DEFAULT	RESTORE

SETTINGS AND ADJUSTMENTS(CONTINUED)

LANGUAGE SETUP

OSD LANGUAGE

The OSD LANGUAGE setup option page allows the user to select the language for the OSD. The user can either select ENGLISH, FRENCH, SPANISH, GERMAN or ITALIAN for the OSD language.

LANGUAGE SETUP	
OSD LANGUAGE	ENGLISH
AUDIO LANG	FRENCH
SUBTITLE LANG	SPANISH
	GERMAN
	ITALIAN

AUDIO LANG

The AUDIO LANG setup option page allows the user can select the audio language (ENGLISH, FRENCH, SPANISH, GERMAN, ITALIAN, CHINESE, JAPANESE or THAI)

Note: The audio selection is only available for discs that are recorded in the above listed languages. If the selected, language is not available, the player will play and display on the screen the original language contained in the disc.

LANGUAGE SETUP	
OSD LANGUAGE	ENGLISH
AUDIO LANG	FRENCH
SUBTITLE LANG	SPANISH
	GERMAN
	ITALIAN
	CHINESE
	JAPANESE
	THAI

SUBTITLE LANG

The SUBTITLE LANG setup option page allows the user to select the language for the OSD. The user can either select ENGLISH, FRENCH, SPANISH, GERMAN, ITALIAN, CHINESE, THAI or OFF to be displayed on the screen during playback of a disc.

Note: The subtitle selection is only available for discs that are recorded in the above listed languages. If the selected, language is not available, the player will play and display on the screen the original language contained in the disc.

LANGUAGE SETUP	
OSD LANGUAGE	ENGLISH
AUDIO LANG	FRENCH
SUBTITLE LANG	SPANISH
	GERMAN
	ITALIAN
	CHINESE
	THAI
	OFF

PLAYING DEVICES

Media Play Mode Selection

The Media Mode support to the following formats:

Audio – Audio data format (MP3, WMA)

Photo – Photo data format (JPEG)

Video – Video data format (MPEG I, II).

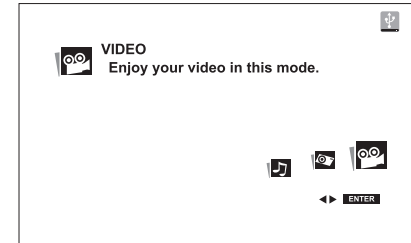
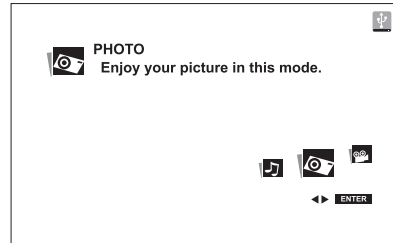
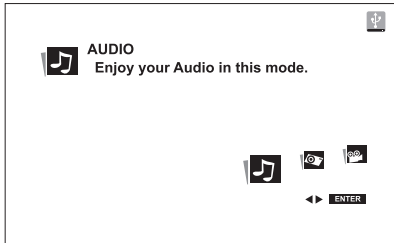

PLAYING USB MEMORY DEVICES

1. The system will detect the insertion of a USB device automatically if no disc is loaded. The system only auto detects the first media inserted (USB drive); the second media source can be manually selected by pressing the front panel Source (S) button or the SOURCE button on the remote control.
2. When a disc is inserted, the system will switch to DVD mode immediately regardless of which type of media (USB) is currently playing.
3. Press the front panel Source (S) button or the SOURCE button on the remote control to select the device source input from DVD, or USB memory device.

NOTE: The system will default to the DVD when the system detects a disc in the DVD player. The system cannot support more than 2 memory partitions on a USB thumb drive

Playing MP3 Discs

MP3 is a format for storing digital audio. An audio CD-quality song can be compressed into the MP3 format with very little loss of quality, while taking up much less space. CD-R discs that have been encoded in MP3 format can be played on your DVD player. The DVD player plays songs in the order they were burned on to the disc. When playback is started the elapsed time of the track that is playing will be displayed.

Selecting of Audio/Photo/Video mode

1. Press ◀ or ▶ to move the highlight to the Audio mode icon and press ENTER. The songs in the folder will be displayed on right side of the menu on screen.

When a device containing MP3 files is loaded to the layer, MP3 song will be played and appears automatically in the directory folder.

2. Press ▲ or ▼ to move the highlight to the desired track containing the song and press ENTER to begin track playback.
3. Press  to return to previous folder.

Skipping Songs

Use the Next (▶▶) button on the remote control to move to the next song. Use the Previous (◀◀) button to move to the previous song.

DVD BASICS

To get the optimum use out of the DVD Player, make sure this section is read completely.

DVD Region Code

The DVD player is preset to a region code at the factory depending on where the DVD player is sold. A DVD from a different region cannot be played in this unit and the unit will display "WRONG REGION".

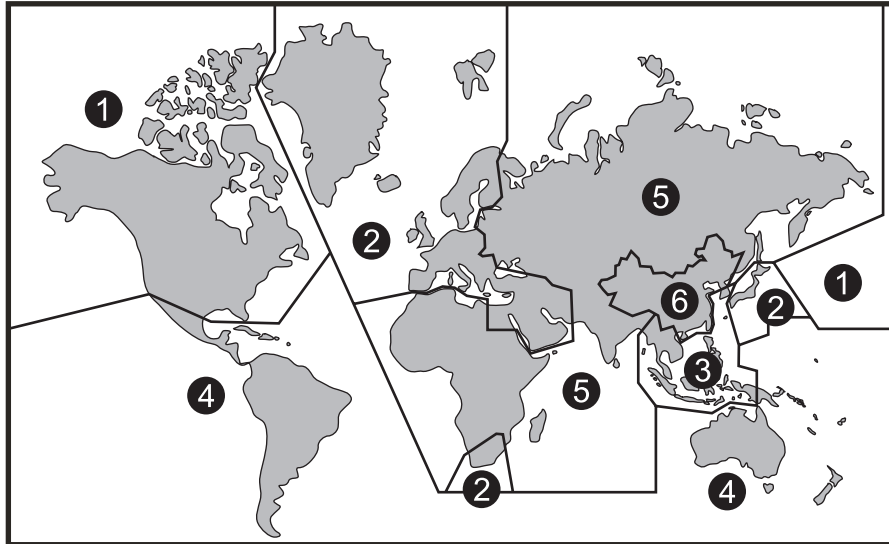

Region 1 - USA, Canada

Region 2 - Japan, Europe, South Africa, Middle East, Greenland

Region 3 - S. Korea, Taiwan, Hong Kong, Parts of South East Asia

Region 4 - Australia, New Zealand, Latin America (including Mexico)

Region 5 - Eastern Europe, Russia, India, Africa

Region 6 - China

Types of Discs the DVD System will play

- DVD* disc - DVD discs that contain video.
- Audio disc - Audio CDs that contain musical or sound content only
- MP3 disc - A disc that contains audio files (for example, a CD-R with downloaded MP3 files).

*This system is capable of playing most recordable DVD formats. However, due to the variety of disc manufacturers and software, playback cannot be guaranteed.

Loading and Playing Discs

Before you load a disc, make sure that it is compatible with the player. Insert the disc with the disc label facing toward the driver.

Note: The following discs **CANNOT** be used with this player:

- MiniDisc
- Laserdisc
- CD-1, CD-ROM, DVD-ROM, Super Audio CD (SACD), DVD Audio JPEG,BD (Blu-ray Disc).

To load and Play a Disc:

Press the Power button to turn the unit ON. Select DVD mode and insert the disc (facing upward) into the disc compartment.

OVERHEAD DOME LIGHTS

The Dome Lights integrated into the unit are controlled by a three position slide switch. Sliding the switch to the ON position will turn the lights ON. The OFF position will prevent the lights from turning ON with the vehicle's interior lighting. The AUTO position will allow the lights to turn ON and OFF with the vehicle's interior lighting. Refer to the Installation Guide for wire connections. Do not leave the vehicle unattended with the dome light switch in the ON position, as this could result in a discharged battery.

ACCESSORIES

WIRELESS HEADPHONES

The ADVEXL10 A includes a built-in infrared transmitter for use with the supplied wireless headphones. The headphone volume is adjusted using the controls on each headset. Any number of wireless headphones may be used but they must be used within a line of sight from the transmitter, as infrared transmissions, like visible light, travel only in a straight line.

Note: If the monitor is set to M2 mode, the headphones supplied with this unit will not work, as these headphones are single channel. Only two-channel wireless headphones will work with this unit when set to M2 mode. The only time it is necessary to set this unit to M2 mode is if there is an RSA (Rear Seat Audio) installed in the vehicle or if two of these monitors are installed in one vehicle. Press the system menu and highlight monitor mode to change the M1 mode to M2 mode or M2 mode to M1 mode.

WIRELESS GAME PACKAGE (MVGP1)

The optional Wireless Game Package MVGP1 consists of 2 game controllers and a game module containing 54 games, 6 of which are two player games.

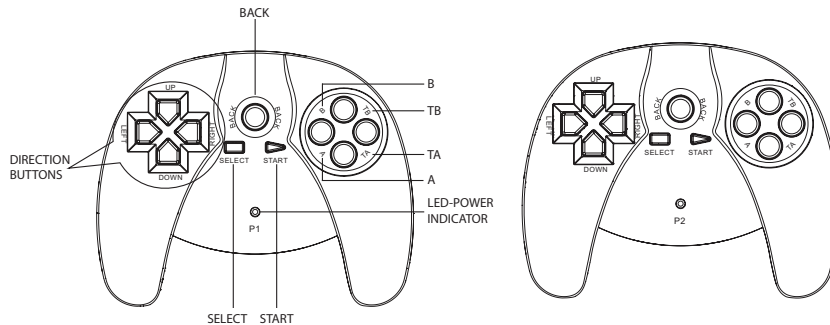

One-Player Games

Use the P1 controller to select and play games.

Two-Player Games

When there are two players, the first player uses the P1 controller. Player 2 uses the P2 controller. The P1 controller is used for game selection. The P2 controller can select a game, but the game can only be started by pressing the START button on P1 controller.

1. A Key: "A Function Key" activates the jump function and optional weapons.
2. B Key: "B Function Key" activates the fire and attack functions.
3. TA Key: TURBO "A" Function Key.
4. TB Key: TURBO "B" Function Key.
5. BACK Key: The Back key is used to return to the previous page. While playing a game pressing the Back button will return to the games list. Pressing the Back button again will return to the games main page "54 Arcade Games".
6. Press the START button to begin the game. Press the START button again at any time to pause the game.
7. Use the SELECT button to exit to the game list.
8. Direction buttons move the arrow to the desired game.

HDMI/MHL AND USB PORT INFORMATION

HDMI1 (HDMI/MHL Input located on the side of the unit)

This input can be used for devices with HDMI or MHL output ports (such as smartphones, tablets, HDMI/MHL devices) and may require the purchase of an HDMI cable and HDMI adapter which is available from your device manufacturer. Each device has unique requirements, please consult with your device or smartphone manufacturer to determine which type of output your device supports.

Note: Some adapters can be powered from the USB port on the side of the unit. Powering the adapter will charge the smartphone when using the smartphone as a media source.

Smartphones and Tablets

For Apple products, go to the Apple Store or enter the following link into your web browser to find the adapter required for your device.

Different models require different adapters.

- <http://support.apple.com/kb/ht4108> *

See the following links for other smartphone and tablet manufacturers:

- Samsung Multimedia adapter: <http://www.samsung.com/us/mobile/cell-phones-accessories/multimedia-adapters> *

Note: Some Samsung smartphones may require an additional 5-pin micro USB to 11-pin micro USB adapter in addition to the multimedia adapter. For other smartphone makes and models check with your device service provider to find an adapter that will work with your device.

- www.amazon.com * is a good source for finding an adapter that will work with your smartphone.

HDMI devices **:

Chromecast media streaming device:

- www.google.com and search for Chromecast

Roku HDMI streaming device:

- <http://www.roku.com/products/compare> *

MHL devices **:

Roku MHL streaming stick: <http://www.roku.com/roku-ready/models> *

Notes:

* Web links can change over time; if the above links do not function go to your device manufacturer's or smartphone service provider's web site for more information.

** These devices require connection to Wi-Fi or a hotspot in order to stream video content from providers such as Netflix, Hulu, Crackle, etc..

Caution: Streaming video can consume large amounts of data when a smartphone is used as a hotspot. Data rates may apply. See your mobile phone service provider for details.

Note: Go to www.adventproducts.com/overhead-mobile-video for more information on available adapters.

USB Port

The USB port provides two functions:

1. Media port for USB thumb drives
 - The Media port allows for the playing of MP3 music files, jpeg files, MPEG I, II files and some video file formats when the USB source is selected.
2. Phone/Tablet charging:
 - When a DVD is playing, the USB port can be used for charging a portable device, but it will be limited to 500 mA of charging current.
 - When the unit is not in DVD mode or USB mode, the USB port can be used for charging a portable device with up to 1.0 Amp of charging current.
 - The USB port will not charge a portable device when the ADVEXL10 A is turned off.

TROUBLESHOOTING

Problem	Solution
IR remote is inoperative.	<ul style="list-style-type: none"> • Verify that the batteries in the remote are fresh. • Verify that the remote sensor eye is not obstructed. • If the monitor is set to M1, press the M1 button on the remote control. If the monitor is set to M2, press the M2 button on the remote control. (See page 8.)
Disc won't play.	<ul style="list-style-type: none"> • Insert a disc with the label side facing upwards. • Check the type of disc you put into disc tray. This DVD only plays DVD, audio CD and MP3. Blu-ray (BD) discs will not play in this player. • Both the unit and the disc are coded by region. If the regional codes don't match, the disc can't be played.
Play starts, but then stops immediately.	<ul style="list-style-type: none"> • The disc is dirty. Clean it. • The disc is damaged. Try another disc. • Condensation has formed. Allow player to dry out.
No sound or distorted sound.	<ul style="list-style-type: none"> • Make sure the DVD is connected properly. Make sure all cables are securely inserted into the appropriate jacks. • If the 2-channel IR headphones are being used, turn on the IR headphone power, and make sure the correct channel (A-B) is selected. • Make sure the FM Modulator is ON and the proper Frequency has been selected. • Make sure that unit is set to M1 when using Single Channel Headphones
Can't advance through a movie.	<ul style="list-style-type: none"> • You can't advance through the opening credits and warning information that appears at the beginning of a movie because the disc is programmed to prohibit that action.
(⊘) Not allowed at the moment.	<p>The feature or action cannot be completed at this time because:</p> <ol style="list-style-type: none"> 1. The disc's software restricts it. 2. The disc's software doesn't support the feature (for example, angles). 3. The feature is not available at the moment. 4. The requested title or chapter number is out of the range.

Problem	Solution
Picture is distorted.	<ul style="list-style-type: none"> • The disc might be damaged, try another disc. • It is normal for some distortion to appear during forward or reverse scan.
No forward or reverse scan.	<ul style="list-style-type: none"> • Some discs have sections that prohibit rapid scanning or title and chapter skip. • If you try to skip through the warning information and credits at the beginning of a movie, you won't be able to. This part of the movie is often programmed to prohibit skipping through it.
HDMI/MHL input not working for the HDMI/MHL enabled device.	<ul style="list-style-type: none"> • May require a special HDMI/MHL adapter. Contact your HDMI/MHL device supplier for the adapter. • Some devices may need to boot up before showing picture.
Game source does not work	<ul style="list-style-type: none"> • The Game source can not be selected (grayed out) if the MVGP1 Game Module is not installed. Make sure the MVGP1 Game Module is installed and plugged in.
DTV source does not work	<ul style="list-style-type: none"> • The DTV source can not be selected (grayed out) if the DTV Module is not installed. Make sure the DTV is installed and plugged in.
AV source does not work	<ul style="list-style-type: none"> • The AV source cannot be selected (grayed out). The DTV module is installed. This input is shared with DTV input.
NO SIGNAL displayed on screen	<ul style="list-style-type: none"> • No source plugged into the A/V, AUX, MEDIA or HDMI input. • Some devices may need to boot up before showing picture.

REPLACEMENT PARTS

Remote Control	136-5326
Wireless Headphones	136-5301
MVGP1 Game Module	136-5319
Game Controller P1	136-5320
Game Controller P2	136-5321

SPECIFICATIONS

LCD Backlighting	LED
Resolution	1024 (RGB) x 600
Pixels	1,843,200
Operation Temperature	32 ~131° F (0 ~ 55° C)
Storage Temperature	-4 ~ 158° F (-20 ~ 70° C)
Back Light Life	20,000 Hours
Video Display System	NTSC / PAL
Video Output	1.0 Vp-p @ 75 ohms
Power Source	12 VDC
Dimensions	L x W x H
	10.67" x 12.0" x 2.12 Closed 271mm x 305mm x 54mm Closed
	10.67" x 12.0" x 8.97 Open 271mm x 305mm x 228mm Open

Specifications are subject to change without notice.



LIMITED WARRANTY

Applies to ADVENT Mobile Video Products



VOXX ELECTRONICS CORP. (the Company) warrants to the original retail purchaser of this product that, should this product or any part thereof (except game controllers), under normal use and conditions, be proven defective in material or workmanship within 36 months from the date of original purchase, such defect(s) will be repaired or replaced with reconditioned product (at the Company's option) without charge for parts and repair labor.

If your new vehicle's radio, CD/DVD player is covered by the manufacturer's warranty for a period of 48 months as set forth in the OEM Warranty Booklet, the company will extend the Advent Mobile Video product warranty for the same period of time. This is not applicable to extended warranty purchases beyond the original manufacturer's warranty. A game controller, if supplied, is similarly warranted for ninety (90) days.

To obtain repair or replacement within the terms of this Warranty, the product is to be delivered with proof of warranty coverage (e.g. dated bill of sale), specification of defect(s), transportation prepaid, to the Company at the address shown below.

This Warranty does not extend to the elimination of externally generated static or noise, to correction of antenna problems, to costs incurred for installation, removal or reinstallation of the product, or to damage to digital memory/media devices, gaming devices, discs, speakers, accessories, or vehicle electrical systems.

This Warranty does not apply to any product or part thereof which, in the opinion of the Company, has suffered or been damaged through alteration, improper installation, mishandling, misuse, neglect, accident, or by removal or defacement of the factory serial number/bar code label(s). THE EXTENT OF THE COMPANY'S LIABILITY UNDER THIS WARRANTY IS LIMITED TO THE REPAIR OR REPLACEMENT PROVIDED ABOVE AND, IN NO EVENT, SHALL THE COMPANY'S LIABILITY EXCEED THE PURCHASE PRICE PAID BY PURCHASER FOR THE PRODUCT.

This Warranty is in lieu of all other express warranties or liabilities. ANY IMPLIED WARRANTIES, INCLUDING ANY IMPLIED WARRANTY OF MERCHANTABILITY, SHALL BE LIMITED TO THE DURATION OF THIS WRITTEN WARRANTY. ANY ACTION FOR BREACH OF ANY WARRANTY HEREUNDER INCLUDING ANY IMPLIED WARRANTY OF MERCHANTABILITY MUST BE BROUGHT WITHIN A PERIOD NOT EXCEEDING 12 MONTHS AFTER EXPIRATION OF THE WARRANTY. IN NO CASE SHALL THE COMPANY BE LIABLE FOR ANY CONSEQUENTIAL OR INCIDENTAL DAMAGES FOR BREACH OF THIS OR ANY OTHER WARRANTY, LOSS OF REVENUE OR LOSS OF ACTUAL OR ANTICIPATED PROFITS (INCLUDING LOSS OF PROFITS ON CONTRACTS). No person or representative is authorized to assume for the Company any liability other than expressed herein in connection with the sale of this product.

Some states do not allow limitations on how long an implied warranty lasts or the exclusion or limitation of incidental or consequential damage so the above limitations or exclusions may not apply to you. This Warranty gives you specific legal rights and you may also have other rights which vary from state to state.

VOXX Electronics Corporation, 150 Marcus Blvd., Hauppauge, New York 11788 • 1-800-645-4994



128-9328B

NOTES



For Customer Service
Visit Our Website At
www.adventproducts.com
Product Information, Photos,
FAQ's, Owner's Manuals