

ADVDLX10
10.1" OVERHEAD LED BACKLIT
LCD MONITOR WITH
DVD PLAYER

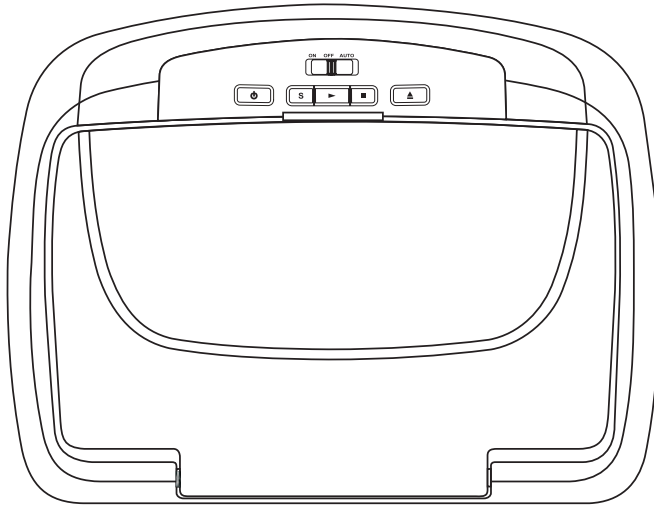

///ADVENT®

OWNER'S
MANUAL

FCC Statement

This device complies with Part 15 of the FCC Rules. Operation is subject to the following two conditions: (1) This device may not cause harmful interference, and (2) this device must accept any interference received, including interference that may cause undesired operation. This equipment has been tested and found to comply with the limits for a Class B digital device, pursuant to Part 15 of the FCC Rules. These limits are designed to provide reasonable protection against harmful interference in a residential installation.

- Reorient or relocate the receiving antenna.
- Increase the separation between the equipment and receiver.
- Connect the equipment into an outlet on a circuit different from that to which the receiver is connected.
- Consult the dealer or an experienced radio/TV technician for help.

FCC Caution: Any change or modifications not expressly approved by the party responsible for compliance could void the user's authority to operate this equipment.

Radiation Exposure Statement

This equipment complies with FCC radiation limits set forth for an uncontrolled environment. This equipment should be installed and operated with minimum distance 20cm between the radiator & your body.

Important Notice

Installation of overhead products requires careful planning and preparation. Be extremely careful when working on a vehicle with side curtain air bags. Do not route wires near any portion of the side curtain air bag assemblies. This includes any anchor points in A, B, C or D pillars of the vehicle. Routing wires in these areas or running wires by the side curtain air bags can prevent the side curtain air bag from fully deploying which can result in personal injury to vehicle occupants. If you have any questions regarding wire routing in a vehicle, please contact Audiovox Technical Support at 1-800-225-6074.

When connecting power and ground in a mobile video installation ensure that the ACC wire is fused at the point where it is connected to the vehicle ACC wiring. Failure to do so can result in damage to the vehicle if a short circuit develops between the vehicle connection point and the mobile video product.

An LCD panel and/or video monitor may be installed in a motor vehicle and visible to the driver if the LCD panel or video monitor is used for vehicle information, system control, rear or side observation or navigation. If the LCD panel or video monitor is used for television reception, video or DVD play, the LCD panel or video monitor must be installed so that these features will only function when the vehicle is in "park" or when the vehicle's parking brake is applied.

An LCD panel or video monitor used for television reception, video or DVD play that operates when the vehicle is in gear or when the parking brake is not applied must be installed to the rear of the driver's seat where it will not be visible, directly or indirectly, to the operator of the motor vehicle.

Warnings

- Do not use any solvents or cleaning materials when cleaning the video monitor.
- Do not use any abrasive cleaners, they may scratch the screen.
- Use only a lightly dampened lint free cloth to wipe the screen if it is dirty.
- Lock the LCD screen in the fully closed position when not in use.
- Before putting on headphones always adjust the volume setting to the lowest position.
- Remember to leave the dome light switch in the off or auto positions when the vehicle is unattended, as the dome lights, if left on, can drain the vehicle's battery.
- Do not put pressure on the screen.
- Caution children to avoid touching or scratching the screen, as it may become dirty or damaged.

Licensed under one or more of the following patents,
Patent NOS. 5,775,762 , 5,927,784 and 6,678,892

Congratulations

Congratulations on your purchase of the ADVENT ADVDLX10 DVD Player with drop-down video / monitor. The ADVDLX10 has been designed to give you and your family many years of video entertainment in the mobile environment. Please read the directions that follow to familiarize yourself with the product to ensure that you obtain the best results from your equipment.

Note: Installation options vary, see the individual owner's manuals for each component in your system to obtain a full understanding of each component's operation.

Safety Precaution

For safety reasons, when changing video media, it is recommended that the vehicle is not in motion, and that you do not allow children to unfasten seat belts to change video media or make any adjustments to the system. System adjustments can be accomplished using the remote control, while seat belts remain fastened. Enjoy your ADVENT entertainment system but remember the safety of all passengers remains the number one priority.

FEATURES

- 10.1" TFT (Thin Film Transistor) Active Matrix LCD (Liquid Crystal Display) Monitor
- LED Backlighting
- Built-in DVD Player
- OSD (On Screen Display) for Control of Picture Quality and Functions Selectable (M1 and M2) IR Receive and Transmit Codes (See page 5)
- Switchable Dual Channel IR Infrared Transmitter (See page 5)
- Four Audio / Video Source Inputs (DVD/USB, AV, AUX) (See page 4)
- Dome Lights with Built-in Three Way Switch
- Built-in 100 Channel Wireless FM Modulator
- Last Position Memory for DVD
- Screen Mode Selection (4:3, 16:9)
- Full Function Remote Control
- Backlit Controls
- AV Output via RCA Jacks
- Plays DVD, CD and MP3 Discs

CONTROLS AND INDICATORS DIAGRAM (FRONT VIEW)

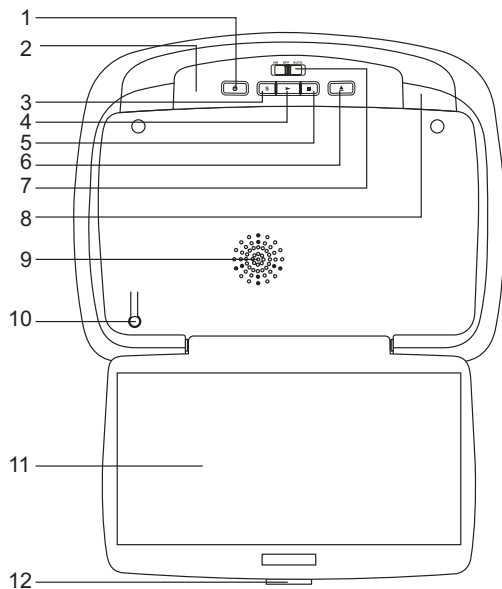

1. POWER (⏻) Button

Used to turn the system on/off (standby).

2. Infrared Transmitter/Remote Sensor

(Location)

3. Source Select (S) Switch

Used to select one of the four sources: DVD/USB, AV, AUX

Note: USB source selection is only available when a USB memory device is connected to the unit.

4. PLAY (▶) Button

This button is used to start playback of a disc.

5. STOP (■) Button

-Press the STOP button once: Stops playback.

-Pressing the PLAY button again will resume normal playback from where movie was stopped.

-Press the STOP button twice and then press the PLAY button to start playback from the beginning of the DVD.

6. EJECT (▲) Button

This button is used for ejecting disc from the disc compartment.

7. Three Position Dome Light Switch

ON - Turns on the dome lights.

OFF - The dome lights will not turn on in this position.

AUTO - Automatically switches on the dome lights in conjunction with the vehicle's interior illumination.

8. Dome Lights

Provide additional interior illumination.

9. Ventilation Openings

10. LCD Cut Off Switch

Used to turn off the LCD backlight when the LCD is in the closed position.

11. LCD Panel

12. Screen Release

Press to release the screen.

CONTROLS AND INDICATORS DIAGRAM SIDE VIEWS

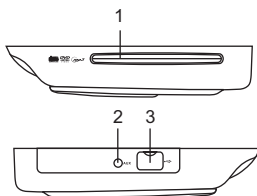

1. DVD Disc Insertion Slot

For loading and removing discs. Insert disc with label side facing up.

2. AUX IN

This jack is used to supply external audio and video inputs to the unit.

Note: In order to connect an external A/V source, the 3.5mm to RCA connectors pigtail is required.

3. USB INPUT

Allows for the connection of an USB memory device.

ADVDLX10 System

The ADVDLX10 System has an option that allows the user to select from two IR transmit and receive codes (M1 or M2). This feature can be used when using two ADVDLX10 systems in the same installation or if the vehicle has RSA (Rear Seat Audio) that uses an "A" channel headset. The ADVDLX10 system comes factory set to M1. When in the M1 mode, the unit will respond to remote commands when M1 is selected on the remote control and will transmit audio on the A channel. When in the M2 mode, the unit will respond to remote commands when M2 is selected on the remote control and will transmit audio on the B channel.

Note: Use 2-channel IR headphones set to CH B when the monitor is set to M2 mode.

Note: M1 will appear on the screen for 4~5 seconds.

Selecting a Monitor Code (M1 or M2)

1. Power ON the unit and wait until M1 on the OSD appears. M1 will appear on the screen for 4~5 seconds.

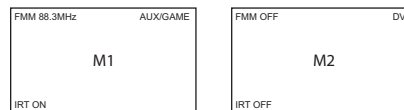

2. To change the monitor code, press the System Menu button.



3. Use the ▲ or ▼ cursor buttons to select the Monitor Mode menu option. Press OK to confirm the setting.
4. Use the ▲ or ▼ cursor buttons to select the desired monitor mode, then press OK to confirm the setting.
5. Press the M2 button on the remote.
6. Press the System Menu button on the remote to exit.

REMOTE CONTROL OPERATION

Initial Use

When purchased, the remote control has a battery installed with a Pull Tab to prevent battery discharge. Remove the Pull Tab before attempting to use the remote control.

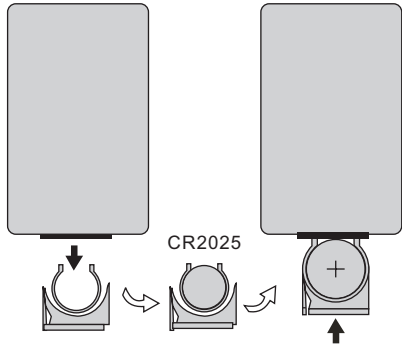

Battery Replacement

1. Remove the battery holder.
2. Insert one CR2025 battery into the battery holder. Be sure to observe the correct polarity.
3. Align the battery holder with the remote control and insert. Push it in until the holder clicks.

REMOTE CONTROL FUNCTIONS

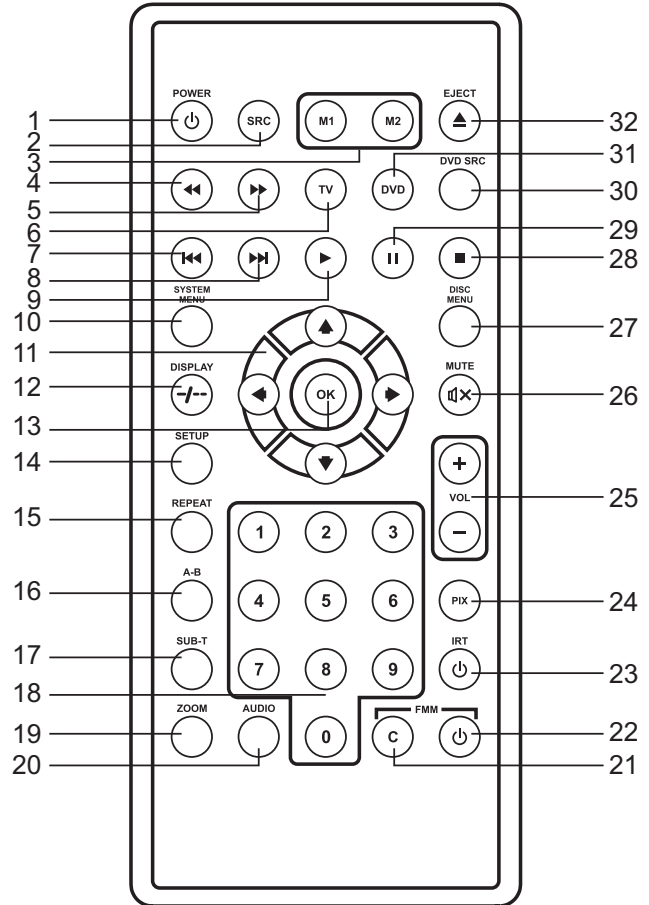

* Function control is available on the unit and the Remote Control.

** Function not available in this model.

1. POWER*

Press this button to turn the unit ON and OFF.

2. SOURCE*

Each time the button is pressed, the unit will cycle through modes DVD/USB, AV, AUX.

3. MONITOR SELECT

M1 Button – Set the remote control code to allow control of the unit in M1 mode.

M2 Button – Set the remote control code to allow control of the unit in M2 mode.

4. SCAN BACKWARD (◀◀)

Press to search in a backward direction. Press repeatedly to change the search speed from 2, 4, 8, 16 times and normal speed.

5. SCAN FORWARD (▶▶)

Press to search in a forward direction. Press repeatedly to change the search speed from 2, 4, 8, 16 times and normal speed.

6. TV Mode Select

Switches certain function keys on the remote control for monitor functions.

7. PREVIOUS (◀◀)

Press to return to the previous chapter or track.

8. NEXT (▶▶)

Press to skip to the next chapter or track.

9. PLAY (▶)*

Press to activate the play mode while a disc is loaded into the disc compartment.

10. SYSTEM MENU

Allows the user to access the system menu when the unit has been placed in TV mode. Press the cursor buttons (▲▼) to select FM MODULATOR, OSD LANGUAGE, DEFAULT DVD ON/OFF, SCREEN MODE, MONITOR MODE.

Note: Press once to access the System Menu, press twice to exit the System Menu.

11. CURSOR (▲▼◀▶)

Use these buttons to access menu selections on the screen.

12. DISPLAY

Press to display the current disc information while the disc is playing. Use the cursor buttons (▲▼) to select the Title or Chapter. For Title/Chapter selection use the numeric buttons to enter the desired Title /Chapter selection.

13. OK

Used to implement a selected setting or menu option.

14. SETUP

Allows the user to access the Setup Menu when the unit has been placed in DVD mode. Use the cursor buttons ▲▼◀▶ to select options such as language, video, rating, Misc.

15. REPEAT

Allows the user to repeat a selected title, chapter, or track.

16. A-B REPEAT

Allows user to repeat the playback from point A to point B.

Press A-B button

On-Screen Display

DVD player

Once

Repeat A

Mark the beginning of the section to repeat (Set point A)

Twice

A-B

Mark the end of the section to repeat (Set point B)

3 times

AB Off

Cancel the A-B repeat function

17. SUBTITLE

Press to display and select the subtitle language in DVD mode. Each time you press the button, the subtitle language changes.

Note: The type and number of languages for subtitles vary from disc to disc.

18. NUMBERS

Allows the user to enter the numbers 0-9 for selection of the tracks, titles, chapters or password setting.

19. ZOOM

Press this button to enlarge the picture when playing a DVD disc.

Press ZOOM button

Once

Twice

3 times

4 times

DVD player

Q1- Enlarges the picture twice the original size

Q2- Enlarges the picture 3 times the original size

Q3- Enlarges the picture 4 times the original size

Q off- Picture is returned to original size

20. AUDIO

Press to display and select audio language in DVD mode. Each time you press the button, the language changes.

Note: The available languages vary from disc to disc.

21. FM MODULATOR CHANNEL SELECT (C)

The unit has a 100 channel built-in wireless FM Modulator. The FM Modulator can be set from 88.1 to 107.9 in 0.2 MHz steps, i.e. 88.1, 88.3, 88.5, 88.9, 90.1 etc. Each time the **C** button on the remote control is pressed, the FM Modulator frequency will increase by 0.2 MHz steps. The FM Modulator menu can be accessed by pressing the System Menu button on the remote control and selecting the FM Modulator menu. Refer to the SYSTEM MENU SETTINGS AND ADJUSTMENTS for more details.

22. FMM ON/OFF

Turns the FM Modulator power on/off.

23. IRT ON/OFF

Turns the Infrared Transmitter on or off for IR wireless headphones.

24. PIX (Picture Select)

Each time this button is pressed, the OSD picture adjustment displays the "Adjustment Bar" for BRIGHTNESS, CONTRAST, COLOR, TINT (For NTSC only) or RESET. Once the desired adjustment bar is displayed, use the VOLUME +/- VOLUME – buttons to adjust the setting. The display will automatically turn off if no adjustments are made within 6 seconds.

25. VOLUME DOWN (-) or UP (+)

Press to decrease or increase the level of the picture adjustments after the picture select button (PIX) is pressed.

Note: The volume up/down will not affect the wireless headphones or the FM Modulator output.

26. MUTE

Press this button to mute the audio for wireless FMM and IR headphones.
Pressing the button again restores the audio to the previously set level.

27. DISC MENU

Allows the user to access the disc's menu mode.

28. STOP (■) *

Press to stop playback. (Playback will resume from the point it is stopped).
Press twice to stop playback fully. (Playback will resume from the beginning of the disc).

29. PAUSE (II)

Press to pause playback.

30. DVD Source

This button is only active when the remote control is in DVD mode. Press to switch between DVD and USB.

31. DVD Mode Select Button

Switches certain function keys on the remote control for DVD function.

32. EJECT (▲)*

Press this button to eject the disc.

TURNING THE UNIT ON OR OFF

1. Push in the Screen Release button to unlock the LCD screen. The screen will drop down slightly.
2. Pivot the screen downward until a comfortable viewing angle is reached. The hinge friction will hold the screen in position while the system is in use.
3. Press the power button on the unit or the remote control to turn the system on and off. When in use, the internal backlighting will illuminate the controls.
4. After the unit has been turned on and is displaying a picture, adjust the viewing angle by pivoting the screen to optimize the picture quality.
5. Remember to turn the unit off and pivot the LCD screen to the locked position when not in use.

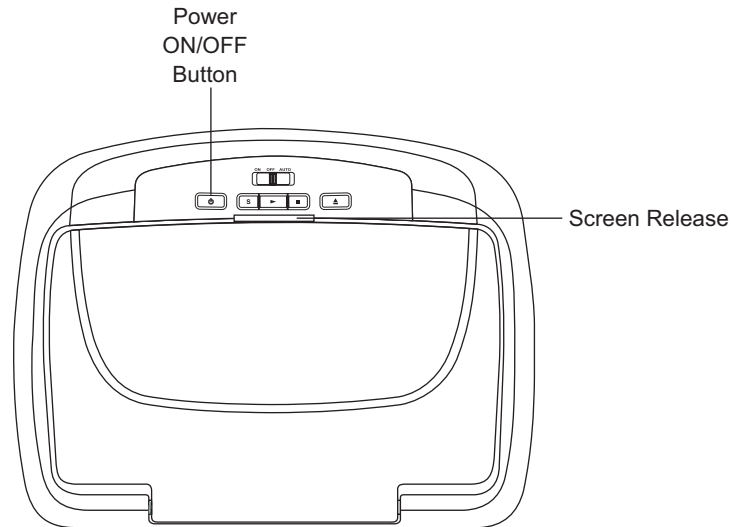

PICTURE CONTROL SELECT

When watching a program, the picture quality can be adjusted to the user's preferences.

1. Press the Picture (PIX) button on the remote control and the on screen picture adjustment displays the "adjustment bar" for BRIGHTNESS, CONTRAST, COLOR, TINT (for NTSC only) or RESET.
2. Use the Volume buttons + or - to adjust the selected adjustment bar for picture quality.

SYSTEM MENU SETTINGS AND ADJUSTMENTS

The System Menu contains features and options that let the user customize the system. For example, the user can change the FM Modulator, OSD language, source default, screen mode display, and the monitor mode.

Using the System Menu

1. Press the TV button and then the SYSTEM MENU button on the remote. The system menu main page will appear on the screen.
2. Use the cursor buttons ▲ or ▼ to select an item in the sub menu and then press OK to select.
3. Press the System Menu button to exit the System Menu.

Note: The System Menu can be controlled via Remote Control only. (Items selected in the menu will have a green background.)

FM MODULATOR

The FM Modulator allows the user to listen to audio through the vehicle's radio.

ON - Turns the wireless FM Modulator on if audio playback through your vehicle's radio is preferred.

OFF - Turns the wireless FM Modulator off.

FM CHANNEL - Allows the user to select the wireless FM Modulator frequency. The unit has a 100 channel built-in wireless FM Modulator. The FM Modulator can be set from 88.1 to 107.9 in 0.2 MHz steps, i.e. 88.1, 88.3, 88.5, 88.9, 90.1 etc.

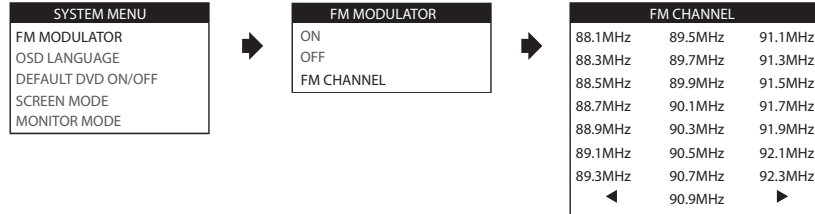

To choose an FM frequency for audio playback through your vehicle's radio:

1. Press the TV button on the remote control, then press the SYSTEM MENU button to access the System Menu. Press OK to access the FM Modulator settings.
2. Use the ▼ cursor button to select FM CHANNEL, then press OK. The FM CHANNEL screen will appear.
3. Use the ▲ ▼ ◀ or ▶ cursor buttons to select a frequency not used by a radio station in the area. Press OK to select the highlighted frequency. There are a total of 5 FM CHANNEL pages containing frequencies from 88.1 to 107.9 in 0.2 MHz steps. To access the additional FM Channel pages, use the ▲ ▼ ◀ or ▶ cursor buttons to highlight the on screen left and right arrows and press OK. Once you have selected a frequency, tune your vehicle's radio to the selected frequency.
4. Press the System Menu button to restore control of the DVD functions.

Note: The wireless FM modulator will perform well in most applications. However, in certain applications the quality of the wireless signal may be less than optimal, resulting in static or strong local station bleed through.

OSD LANGUAGE

This function allows the user to select the on-screen display language. The user can select English, Spanish, French or German for the OSD language.

1. Press the System Menu button.
2. Use the ▲ or ▼ cursor buttons to highlight OSD LANGUAGE and press OK to access the OSD submenu.
3. Use the ▲ or ▼ cursor buttons to select the language.
4. Press the OK to confirm the setting.

SOURCE DEFAULT DVD ON/OFF

This allows the user to set the system default source to DVD. If source default is set to ON, every time the unit is turned off then on, the unit will power up and automatically switch the source to DVD. If source default is set to OFF and the unit is turned off then on, the unit will power up in the source that was last selected. The user can set the system default source to DVD

1. Press the System Menu button.
2. Use the ▲ or ▼ cursor buttons to highlight DEFAULT DVD ON/OFF and press OK to access the submenu.
3. Use the ▲ or ▼ cursor buttons to select ON or OFF.
4. Press the OK to confirm the setting .

Note: The unit is set to source default DVD on as the default mode of operation. Selection of Source default can only be made from within the system menu.

SCREEN MODE SELECT

This allows the user to change the screen format (aspect ratio 4:3, 16:9).

To select the screen aspect ratio format:

1. Press the System Menu button.
2. Use the ▲ or ▼ cursor buttons to highlight SCREEN MODE and press OK to access the screen mode submenu.
3. Use the ▲ or ▼ cursor buttons to select 4:3 or 16:9.
4. Press the OK to confirm the setting.

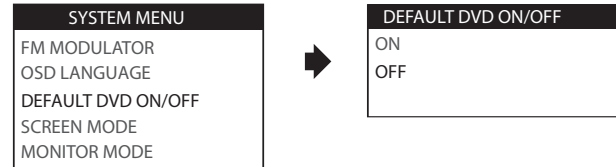

MONITOR MODE

This allows the user to set the system monitor code M1/M2.

1. Press the System Menu button.
2. Use the ▲ or ▼ cursor buttons to highlight MONITOR MODE and press OK to access the monitor mode submenu.
3. Use the ▲ or ▼ cursor buttons to select M1 or M2.
4. Press the M2 button on the remote control after selecting M2.
5. Press OK to confirm the setting.

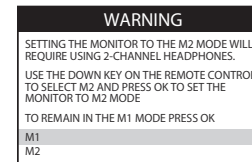
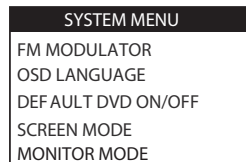

DVD SETUP MENU SETTINGS AND ADJUSTMENTS

The DVD Setup Menu contains features and options that let the user customize the DVD player. For example, the user can set a language for the on-screen display or prevent children from viewing DVD playback of adult DVD Titles.

Using the Setup Menu

Press the DVD button and then the SETUP button on the remote. The Setup Menu appears on the screen as shown.

1. Use the ▲ or ▼ cursor buttons to highlight the settings to be changed. Use the ► cursor button to highlight the sub-settings. Use the ► cursor button to open the submenu that contains the different options available. Press OK to set the desired option.
2. Use the ◀ cursor button to position the highlight back on the icon side of the setup page to set the other options. Repeat steps 1-2.
3. Press the SETUP button again to exit the Setup Menu.



LANGUAGE SETUP

DVD Language for On-Screen Display

The Language Menu allows the user to select the language for the on-screen display.

The user can select English, French, Spanish, German or Italian for the OSD language.

1. Press the SETUP button on the remote to enter the Setup Menu.
2. Use the ▲ or ▼ cursor buttons to select the Language menu option
3. Use the ► cursor button to select language submenu.
4. Use the ► cursor button to select language choices
5. Use the ▲ or ▼ cursor buttons to select the desired language, then press OK to confirm the setting.
6. Press the SETUP button on the remote to exit the Setup Menu.

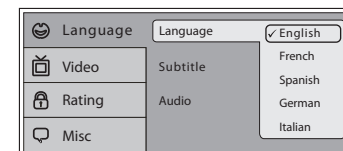

DVD SUBTITLE SETUP

The Subtitle Menu allows the user to select the language for the on-screen display subtitles.

1. Press the SETUP button on the remote to enter the Setup Menu.
2. Use the ▲ or ▼ cursor buttons to select the Language menu option.
3. Use the ► cursor button to select subtitle submenu.
4. Use the ▼ cursor button to select the subtitle option.
5. Use the ► cursor button to select subtitle submenu.
6. Use the ▲ or ▼ cursor buttons to select the desired subtitle language, then press OK to confirm the setting.
7. Press the SETUP button on the remote to exit the Setup Menu.

Note: The subtitle selection is only available for discs that are recorded in the languages listed in the diagram. If the selected language is not available, the player will play and display on the screen the original language contained in the disc.

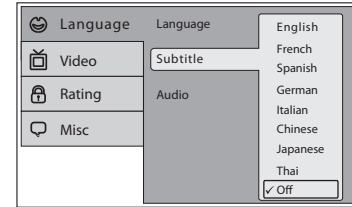

DVD AUDIO SETUP

The Audio Menu allows the user to select the language for audio.

1. Press the SETUP button on the remote to enter the Setup Menu.
2. Use the ▲ or ▼ cursor buttons to select the Language menu option.
3. Use the ► cursor button to select audio submenu.
4. Use the ▼ cursor button to select the audio option.
5. Use the ► cursor button to select audio submenu.
6. Use the ▲ or ▼ cursor buttons to select the DVD language you desire, then press OK to confirm the setting.
7. Press the SETUP button on the remote to exit the Setup Menu.

Note: The audio language selection is only available for discs that are recorded in the listed languages. If the selected language is not available, the player will play and display on the screen the original language contained in the disc.

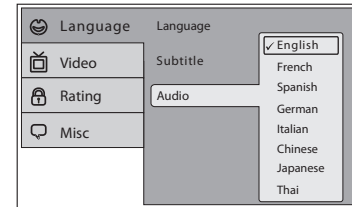

DVD TV DISPLAY

The TV display setup allows the user to set the screen aspect ratio.

4:3 - This displays the wide picture with black bands on the upper and lower portions of the screen.

16:9 - This displays a wide picture with black bands on the upper and lower portion of the screen.

The bandwidth will vary, depending on the aspect ratio of the disc.

1. Press the SETUP button on the remote to enter the Setup Menu.
2. Use the ▲ or ▼ cursor buttons to select the Video menu option.
3. Use the ► cursor button to select TV display submenu.
4. Use the ► cursor button to select the desired TV display submenu.
5. Use the ▲ or ▼ cursor buttons to select the desired aspect ratio, then press OK to confirm the setting.
6. Press the SETUP button on the remote to exit the Setup Menu.

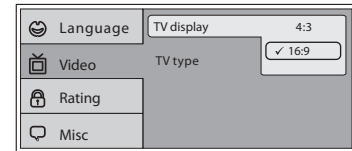

DVD TV Type

The TV Type setup allows the user to select the television standard which corresponds to your TV.

NTSC - Select this type for NTSC TV.

PAL - Select this type for PAL TV.

MULTI - Select this type for multi-system TV.

1. Press the SETUP button on the remote to enter the Setup Menu.
2. Use the ▲ or ▼ cursor buttons to select the Video menu option.
3. Use the ► cursor button to select TV type submenu.
4. Use the ▲ or ▼ cursor buttons to select the TV type menu option.
5. Use the ► cursor button to select the desired TV type submenu.
6. Use the ▲ or ▼ cursor buttons to select the desired TV standard, then press OK to confirm the setting.
7. Press the SETUP button on the remote to exit the Setup Menu.

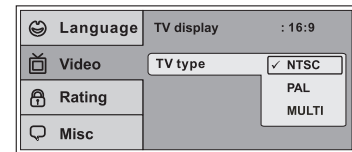

DVD RATING SETUP

Parental

This feature allows the user to limit the content of movie playback from G to Adult. The lower the value, the more strict the control.

1. G
2. PG
3. PG – 13
4. R
5. NC – 17
6. Adult

The rating level can only be changed when the correct password is provided.

To change the parental control level, perform the following:

1. Press the SETUP button on the remote to enter the Setup Menu.
2. Use the ▲ or ▼ cursor buttons to select the Rating menu option.
3. Use the ► cursor button to select parental submenu.
4. Press OK to enter default password (3308) then press OK.
5. Press OK again to select parental submenu.
6. Use the ▲ or ▼ cursor buttons to select the desired rating option, then press OK to confirm the setting.
7. Press the SETUP button on the remote to exit the Setup Menu.

Change Password

To change the password to a unique password:

1. Press the SETUP button on the remote to enter the Setup Menu.
2. Use the ▲ or ▼ cursor buttons to select the Rating menu option.
3. Use the ► cursor button to select parental submenu.
4. Use the ▲ or ▼ cursor buttons to select the change password menu option.
5. Press OK to enter default password (3308) then press OK.
6. Press OK again and key in a new 4 digit password, then press OK to confirm the setting.
7. Press the SETUP button on the remote to exit the Setup Menu.

Note: The Default Password is 3308. This password is always effective even after you have selected your own password and changed it. To avoid the possibility of others using the default password to set the parental level and change the password, you can record this default password in another area and delete it from this manual. Some discs can be limited depending on the age of users while some discs cannot.

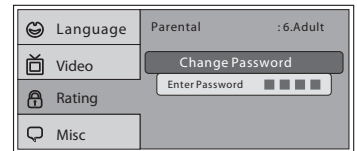
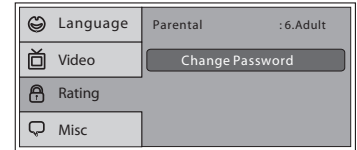

Load Factory

This option allows the user to reset all options to factory settings.

1. Press the SETUP button on the remote to enter the Setup Menu.
2. Use the ▲ or ▼ cursor buttons to select the Misc menu option.
3. Use the ► cursor button to select the load factory option, then press OK to enter the submenu.
4. Use the ◀ or ▶ cursor buttons to select the load factory Yes or No, then press OK to confirm the setting.
5. Press the SETUP button on the remote to exit the Setup Menu.

Note: This function will not affect the Rating control settings.

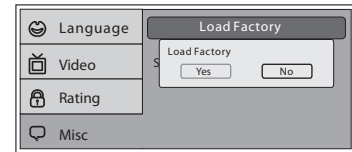
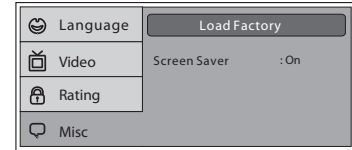

Screen Saver

This option allows the user to set the Screen Saver mode.

ON - Screen saver will appear

OFF - Screen saver will not appear

1. Press the SETUP button on the remote to enter the Setup Menu.
2. Use the ▲ or ▼ cursor buttons to select the Misc menu option.
3. Use the ► cursor button to select the screen saver submenu.
4. Use the ▼ cursor button to select the screen saver option, then press OK to enter the submenu.
5. Use the ▲ or ▼ cursor buttons to select the screen saver on or off, then press OK to confirm the setting.
6. Press the SETUP button on the remote to exit the Setup Menu.

Note: The DVD player will enter Screen Saver mode if the unit is inactive for approximately 2 minutes.

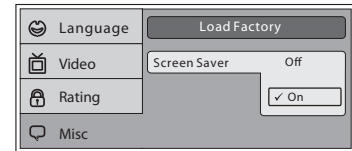

PLAYING DVDS

1. Press the DISPLAY button on the remote control to display the status banner. The banner includes title, chapter, angle, audio, subtitle, and time.
2. **Title Selection**
Press the numeric (0~9) buttons to initiate a change of title selection. Then press OK to implement the selection.
3. **Chapter Selection**
Press the numeric (0~9) buttons to initiate a change of chapter selection. Then press OK to implement the selection.

PLAYING MP3 DISCS

MP3 is a format for storing digital audio. An audio CD-quality song can be compressed into the MP3 format with very little loss of quality, while taking up much less space. CD-R discs that have been encoded in MP3 format can be played on the DVD player. The DVD player plays the songs in the order they were burned onto the disc. When playback is started, the elapsed time of the track that is playing will be displayed.

Selecting Folders and Songs

When a device containing MP3 files is loaded in the player, the navigation menu appears automatically.

1. Use the ▲ or ▼ cursor buttons to select the desired folder (if present) on the left side of the menu and press OK. The songs in the folder will be displayed on screen.
2. Use the ▲ or ▼ cursor buttons to select the desired track containing the song and press OK to begin track playback.

Skipping Songs

Use the Next (▶▶) button on the remote control to move to the next song. Use the Previous (◀◀) button to move to the previous song.

Selecting a Play Mode

Filter (For MP3 & JPEG only)

The Filter Mode enables or disables the display of files contained on the media based on their file extension.

The filter function applies to the following formats:

Audio - Audio data format (MP3, WMA)

Photo - Photo data format (JPEG)

Video - Video data format (MPEG I, II)

Flat Mode: play the entire disc

This mode is always on (default). During the Flat Mode, all the data folder with MP3, JPEG, and movies will be played in sequence. If the Flat Mode function is off, it will only play the selected folder; other folders are disabled.

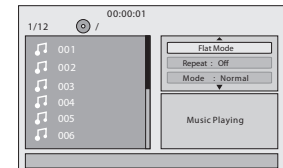
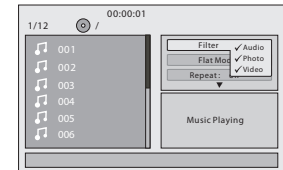

Repeat: play repetitively

The Repeat function has four playing options: Off, Single, Folder, and All. Move the cursor to the Repeat function and press OK. Each time OK is pressed the unit will cycle through the available options. Off/Single/Folder/All are displayed in that order. The Repeat default is Off.

- Off** - Turns the repeat function off.
- Single** - Repeats the song being played until STOP is pressed.
- Folder** - Plays all songs in a folder repetitively.
- All** - Plays all songs on the disc repetitively.

Mode: play mode

The Mode function has 4 options: Normal, Shuffle, Random and Music Intro. Move cursor to the Mode function area and press OK repeatedly until the desired mode is displayed.

Normal/Shuffle/Random/Music Intro are displayed in that order. The Mode function default is Normal.

- Normal** - Plays all songs in folder once.
 - Shuffle** - Plays songs in a folder in a shuffle order. Each song in the folder is played only once.
 - Random** - Plays songs in a folder in a random order. Each song in a folder is only be played once.
 - Music Intro** - Plays each song in order in the folder for 10 seconds.
- Remark** - The Music Intro function provides the user with a sample of each song for 10 seconds, thereby making it easy to select and listen to a favorite song.

Add to program

To add the selected songs into Browser view, make sure disc playback is off. Move the cursor to the Edit mode function and press OK. After Edit mode is selected, move cursor to songs list and select the songs which will be compiled. Press OK. A check mark appears to the left of the selected song.

To add the selected songs to the program, move cursor to the "Add to program" function and press OK. The selected songs are added into a new program list and the check mark will disappear on the playlist. Move the cursor to the "Program view" function and press OK to browse the songs in the program. Press the PLAY button to play the selected songs.

Clear program

To clear the selected song files, press the STOP button twice during playback mode. Move the cursor to the Edit mode function and press OK. After Edit mode is selected, move cursor to selected songs list and select the songs which you want to delete. Press OK. A check mark will appear to the left of the selected song. Move the cursor to clear program and press OK. The selected songs will be deleted from the play list.

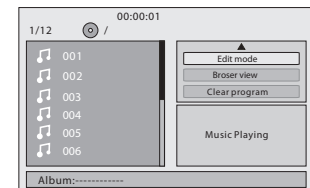
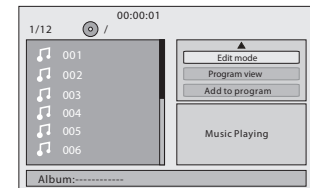
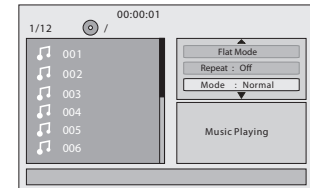
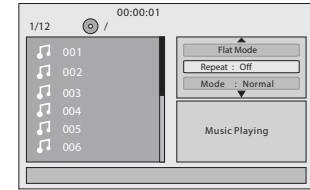

DVD Basics

To get the optimum use out of the DVD Player, make sure this section is read completely.

DVD Region Code

The DVD player is preset to a region code at the factory depending on where the DVD player is sold. A DVD from a different region cannot be played in this unit and the unit will display "WRONG REGION".

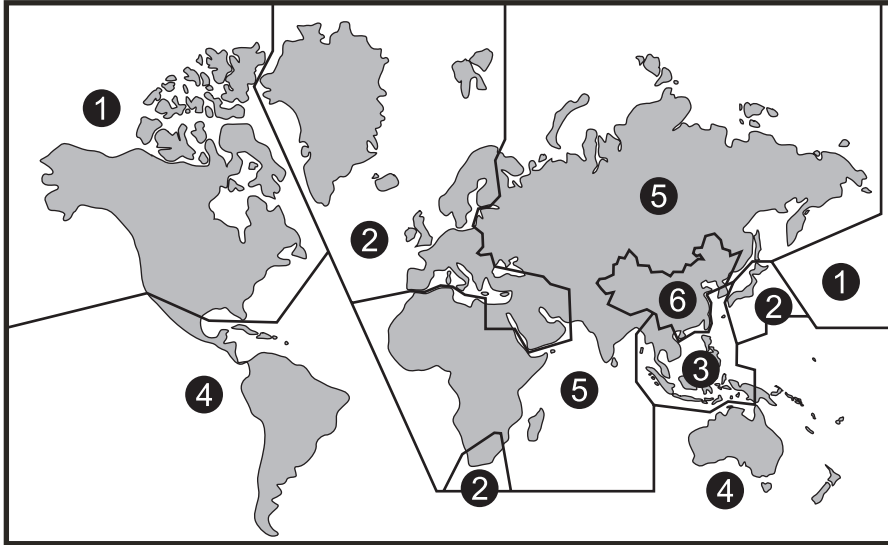

Region 1 - USA, Canada

Region 2 - Japan, Europe, South Africa, Middle East, Greenland

Region 3 - S. Korea, Taiwan, Hong Kong, Parts of South East Asia

Region 4 - Australia, New Zealand, Latin America (including Mexico)

Region 5 - Eastern Europe, Russia, India, Africa

Region 6 - China

Types of Discs the DVD System will play

The ADVDLX10 DVD system will play the following types of discs:

- DVD* disc - DVD discs which contain video.
- Audio disc - Audio CDs contain musical or sound content only.
- MP3 disc - A disc that contains audio files (for example, a CD-R with downloaded MP3 files).
- JPEG disc - A disc that contains JPEG files.

***Note:** This system is capable of playing most recordable DVD formats. However, due to the variety of disc manufacturers and software, playback cannot be guaranteed.

Loading and Playing Discs

Before you load a disc, make sure that it is compatible with the player. Insert the disc with the label facing the vehicle's headliner.

Note: The following discs **CANNOT** be used with this player:

- MiniDisc
- Laserdisc
- CD-1, CD-ROM, DVD-ROM, Super Audio CD (SACD), DVD Audio
- Blu-ray Disc
- Digital Copy Discs

To load and play a disc:

1. Press the Power button to turn the unit on.
2. Select DVD mode and insert the disc (label facing upwards) into the disc compartment.

OVERHEAD DOME LIGHTS

The Dome Lights integrated into the unit are controlled by a three position slide switch. Sliding the switch to the ON position will turn the lights ON. The OFF position will prevent the lights from turning ON with the vehicle's interior lighting. The AUTO position will allow the lights to turn ON and OFF with the vehicle's interior lighting. Refer to the Installation Guide for wire connections. Do not leave the vehicle unattended with the dome light switch in the ON position, as this could result in a discharged battery.

ACCESSORIES

WIRELESS HEADPHONES

The ADVDLX10 includes a built-in infrared transmitter for use with the supplied wireless headphones. The headphone volume is adjusted using the controls on each headset. Any number of wireless headphones may be used but they must be used within a line of sight from the transmitter, as infrared transmissions, like visible light, travel only in a straight line.

Note: If the monitor is set to M2 mode, the headphones supplied with this unit will not work, as these headphones are single channel. Only two-channel wireless headphones will work with this unit when set to M2 mode. The only time it is necessary to set this unit to M2 mode is if there is an RSA (Rear Seat Audio) installed in the vehicle or if two of these monitors are installed in one vehicle. Press the system menu and highlight monitor mode to change the M1 mode to M2 mode or M2 mode to M1 mode.

SOURCE FEATURE

AV

An external video source, video game system, or other audio/video devices can be connected to the AV input. To access the audio / video inputs, inputs, turn the unit on and press the S (source) button or the SRC button on the remote control until "AV" is displayed on the screen. Turn the video source component on with its power button or remote control and it is now ready to play the audio and video signals from the source connected to AV.

AUX

The AUX input may be connected to a external video source, video game system or other audio/video devices via AUX harness input, turn the unit ON and press the S (Source) button or the SRC button on the remote until "AUX" is displayed on screen. Turn the video source component on with its power button or remote control and it is now ready to play the audio and video signal from the source connected to AUX.

AV Out

The unit provides an AV output for optional video monitor(s). This output will provide the AV signals that duplicate the picture/audio being processed by the unit to an additional monitor or video display. Please see your installer for more information.

TROUBLESHOOTING

Problem	Solution
IR remote is inoperative.	<ul style="list-style-type: none"> • Verify that the batteries in the remote are fresh. • Verify that the remote sensor eye is not obstructed. • If the monitor is set to M1, press the M1 button on the remote control. If the monitor is set to M2, press the M2 button on the remote control. (See page 5.)
Disc won't play.	<ul style="list-style-type: none"> • Insert a disc with the label side facing upwards. • Check the type of disc you put into disc tray. This DVD only plays DVD, audio CD and MP3. Blu-ray (BD) discs will not play in this player. • Both the unit and the disc are coded by region. If the regional codes don't match, the disc can't be played.
Play starts, but then stops immediately.	<ul style="list-style-type: none"> • The disc is dirty. Clean it. • The disc is damaged. Try another disc. • Condensation has formed. Allow player to dry out.
No sound or distorted sound.	<ul style="list-style-type: none"> • Make sure the DVD is connected properly. Make sure all cables are securely inserted into the appropriate jacks. • If the 2-channel IR headphones are being used, turn on the IR headphone power, and make sure the correct channel (A-B) is selected. • Make sure the FM Modulator is ON and the proper Frequency has been selected. • Make sure that unit is set to M1 when using Single Channel Headphones
Can't advance through a movie.	<ul style="list-style-type: none"> • You can't advance through the opening credits and warning information that appears at the beginning of a movie because the disc is programmed to prohibit that action.
Ⓞ Not allowed at the moment.	<p>The feature or action cannot be completed at this time because:</p> <ol style="list-style-type: none"> 1. The disc's software restricts it. 2. The disc's software doesn't support the feature (for example, angles). 3. The feature is not available at the moment. 4. The requested title or chapter number is out of the range.

Problem	Solution
Picture is distorted.	<ul style="list-style-type: none">• The disc might be damaged, try another disc.• It is normal for some distortion to appear during forward or reverse scan.
No forward or reverse scan.	<ul style="list-style-type: none">• Some discs have sections that prohibit rapid scanning or title and chapter skip.• If you try to skip through the warning information and credits at the beginning of a movie, you won't be able to. This part of the movie is often programmed to prohibit skipping through it.

REPLACEMENT PARTS**SPECIFICATIONS**

Remote Control 136-5326

AV Adapter Pigtail 112B3227

LCD Backlighting

LED

Resolution

1024 (RGB) x 600

Pixels

1,843,200

Operation Temperature

32 ~131° F (0 ~ 55° C)

Storage Temperature

-4 ~ 158° F (-20 ~ 70° C)

Back Light Life

20,000 Hours

Video Display System

NTSC / PAL

Video Output

1.0 Vp-p @ 75 ohms

Power Source

12 VDC

Dimensions

L x W x H

11.0" x 9.5" x 1.7" Closed

289mm x 243mm x 44mm Closed

11.0" x 9.5" x 8.5 Open

289mm x 243mm x 215.9mm Open

Specifications are subject to change without notice.



LIMITED WARRANTY

Applies to ADVENT Mobile Video Products



VOXX ELECTRONICS CORP. (the Company) warrants to the original retail purchaser of this product that, should this product or any part thereof (except game controllers), under normal use and conditions, be proven defective in material or workmanship within 36 months from the date of original purchase, such defect(s) will be repaired or replaced with reconditioned product (at the Company's option) without charge for parts and repair labor.

If your new vehicle's radio, CD/DVD player is covered by the manufacturer's warranty for a period of 48 months as set forth in the OEM Warranty Booklet, the company will extend the Advent Mobile Video product warranty for the same period of time. This is not applicable to extended warranty purchases beyond the original manufacturer's warranty. A game controller, if supplied, is similarly warranted for ninety (90) days.

To obtain repair or replacement within the terms of this Warranty, the product is to be delivered with proof of warranty coverage (e.g. dated bill of sale), specification of defect(s), transportation prepaid, to the Company at the address shown below.

This Warranty does not extend to the elimination of externally generated static or noise, to correction of antenna problems, to costs incurred for installation, removal or reinstallation of the product, or to damage to digital memory/media devices, gaming devices, discs, speakers, accessories, or vehicle electrical systems.

This Warranty does not apply to any product or part thereof which, in the opinion of the Company, has suffered or been damaged through alteration, improper installation, mishandling, misuse, neglect, accident, or by removal or defacement of the factory serial number/bar code label(s). THE EXTENT OF THE COMPANY'S LIABILITY UNDER THIS WARRANTY IS LIMITED TO THE REPAIR OR REPLACEMENT PROVIDED ABOVE AND, IN NO EVENT, SHALL THE COMPANY'S LIABILITY EXCEED THE PURCHASE PRICE PAID BY PURCHASER FOR THE PRODUCT.

This Warranty is in lieu of all other express warranties or liabilities. ANY IMPLIED WARRANTIES, INCLUDING ANY IMPLIED WARRANTY OF MERCHANTABILITY, SHALL BE LIMITED TO THE DURATION OF THIS WRITTEN WARRANTY. ANY ACTION FOR BREACH OF ANY WARRANTY HEREUNDER INCLUDING ANY IMPLIED WARRANTY OF MERCHANTABILITY MUST BE BROUGHT WITHIN A PERIOD NOT EXCEEDING 12 MONTHS AFTER EXPIRATION OF THE WARRANTY. IN NO CASE SHALL THE COMPANY BE LIABLE FOR ANY CONSEQUENTIAL OR INCIDENTAL DAMAGES FOR BREACH OF THIS OR ANY OTHER WARRANTY. No person or representative is authorized to assume for the Company any liability other than expressed herein in connection with the sale of this product.

Some states do not allow limitations on how long an implied warranty lasts or the exclusion or limitation of incidental or consequential damage so the above limitations or exclusions may not apply to you. This Warranty gives you specific legal rights and you may also have other rights which vary from state to state.

VOXX Electronics Corporation, 150 Marcus Blvd., Hauppauge, New York 11788 1-800-645-4994

128-9328

NOTES



For Customer Service
Visit Our Website At
www.adventproducts.com
Product Information, Photos,
FAQ's, Owner's Manuals