

ADV850S/P
8.5" OVERHEAD LCD
MONITOR WITH
DVD PLAYER

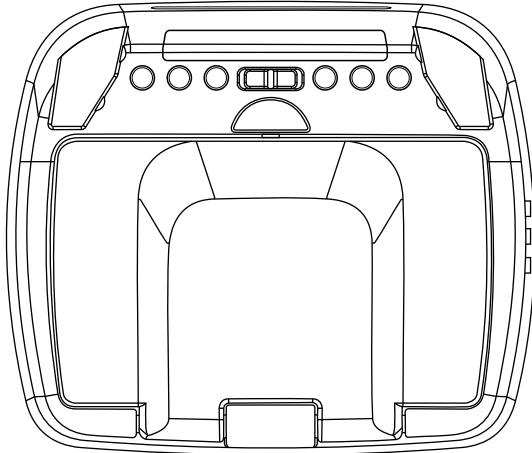

///ADVENT®

OPERATION
MANUAL

128-8469

Important Notice

An LCD panel and/or video monitor may be installed in a motor vehicle and visible to the driver if the LCD panel or video monitor is used for vehicle information, system control, rear or side observation or navigation. If the LCD panel or video monitor is used for television reception, video or DVD play, the LCD panel or video monitor must be installed so that these features will only function when the vehicle is in "park" or when the vehicle's parking brake is applied.

An LCD panel or video monitor used for television reception, video or DVD play that operates when the vehicle is in gear or when the parking brake is not applied must be installed to the rear of the driver's seat where it will not be visible, directly or indirectly, to the operator of the motor vehicle.

Warnings

- Do not use any solvents or cleaning materials when cleaning the video monitor.
- Do not use any abrasive cleaners, they may scratch the screen.
- Use only a lightly dampened lint free cloth to wipe the screen if it is dirty.
- Lock the LCD screen in the fully closed position when not in use.
- Before putting on headphones always adjust the volume setting to the lowest position.
- Remember to leave the dome light switch in the off or auto positions when the vehicle is unattended, as the dome lights, if left on, can drain the vehicle's battery.
- Do not put pressure on the screen.
- Caution children to avoid touching or scratching the screen, as it may become dirty or damaged.

Licensed under one or more of the following patents,
Patent NOS. 5,775,762 and 5,927,784

Congratulations

Congratulations on your purchase of the ADVENT ADV850S/P DVD Player with Drop-Down Video / Monitor. The ADV850S/P has been designed to give you and your family many years of video entertainment in the mobile environment. Please read the directions that follow to familiarize yourself with the product to ensure that you obtain the best results from your equipment.

Please note: Installation options vary, see the individual owner's manuals for each component in your system to obtain a full understanding of each component's operation.

Safety Precaution

For safety reasons, when changing video media it is recommended that the vehicle is not in motion, and that you do not allow children to unfasten seat-belts to change video media or make any adjustments to the system. System adjustments can be accomplished using the remote control, while seat-belts remain fastened. Enjoy your ADVENT entertainment system but remember the safety of all passengers remains the number one priority.



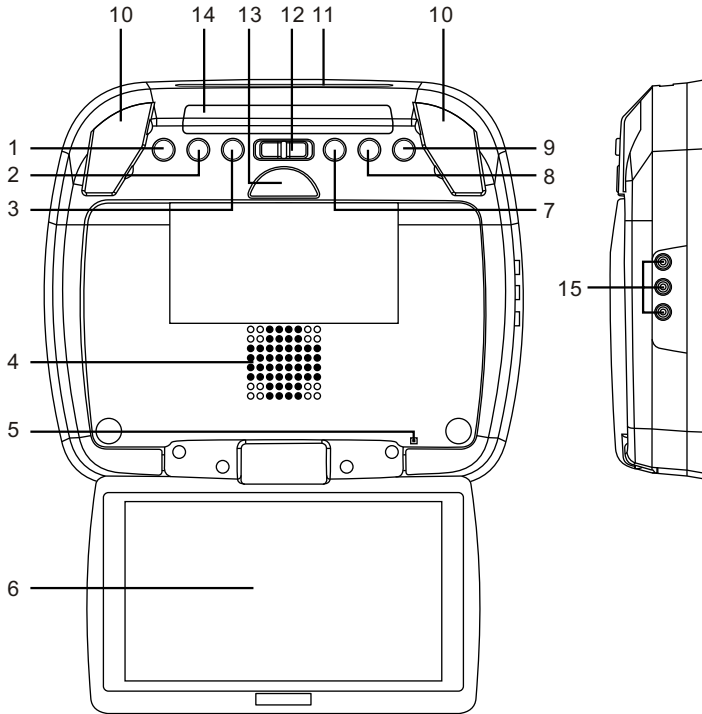

FEATURES

- 8.5" TFT (Thin Film Transistor) Active Matrix LCD (Liquid Crystal Display) Monitor
- OSD (On Screen Display) for Control of Picture Quality and Functions
- Full Function Remote Control
- Built-in Wireless Transmitter for IR Wireless Headphones
- Playing DVD, CD, and MP3 Disc.
- Built-in Five Frequency Wireless FM Modulator
- Built-in Remote Control IR. Sensor
- Dome Lights with 3-Position Switch
- Two Audio/Video Source Inputs (DVD, AUX)

CONTROLS AND INDICATORS DIAGRAM



CONTROLS FUNCTION DESCRIPTIONS

- 1. POWER () Button**
Used to turn the DVD and Monitor system on/off. Bright red when the system is on, dim when off.
- 2. Source Select**
Use to select one of the two sources: DVD, AUX.
- 3. Screen Mode Button**
Allows the user to change the screen format (Aspect Ratio 4:3 or 16:9).
- 4. Ventilation Openings**
- 5. Monitor Cut Off Switch**
Used to turn off monitor when in the closed position.
- 6. Drop Down Panel**
- 7. PLAY () Button**
This button is used to start playback of a disc for DVD.
- 8. Stop () Button**
 - Press STOP once : (Stop) display perform to Stop playback, pressing the PLAY button again will resume normal playback.
 - Press STOP twice : ( Stop) display perform to stop playback.

CONTROL FUNCTION DESCRIPTION

9. EJECT (▲) Button

This Button is used to eject the DVD disc.

10. **Dome Lights** – Provides additional interior illumination.

11. **DVD disc insertion slot** – For loading and removing discs.

12. Three Position Dome Light Switch

ON – Turns on the dome lights.

OFF – The dome lights will not turn on in this position.

AUTO – Automatically switches on the dome lights in conjunction with the vehicle's interior illumination.

13. **Screen Release** – Push to release the screen for monitor.

14. **Infrared Transmitter and Sensor** – Use to transmit audio to the wireless headphones. Also allows the remote control to operate the unit.

15. **Auxiliary Audio/ Video Input**

REMOTE CONTROL OPERATION

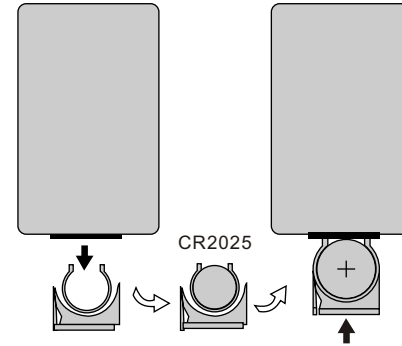

Initial Use

When purchased the remote control has a battery installed with a Pull Tab to prevent battery discharge. Remove the Pull Tab before attempting to use the remote.

Battery Replacement

1. Remove the battery holder.
2. Insert the battery into the battery holder and insert the battery holder into the remote. Be sure to observe the correct polarity.
3. Align the battery holder with the remote control and push until the holder clicks.

MAIN FUNCTION DESCRIPTION

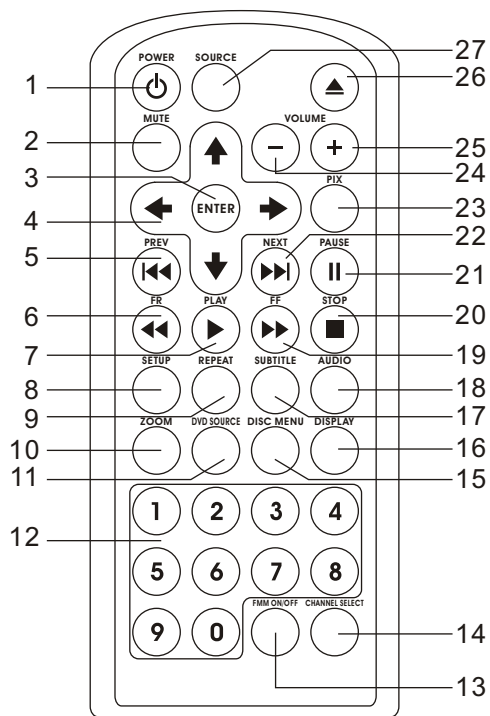

- * Function control is available on the unit and the Remote Control
- ** Function control is not available on this unit..

1. **POWER***
Press this button to turn the unit ON and OFF.
2. **MUTE**
Press to mute the audio. Press it again to restore the sound to the previously set volume.
3. **ENTER**
Press to implement selected settings.
4. **CURSOR (▲▼◀▶)**
Use these buttons to access menu selections on the screen.
5. **PREVIOUS (◀◀)**
Press to return to the previous chapter or track.
6. **SCAN BACKWARD (◀◀◀)**
Press to search in a backward direction. Press repeatedly to change the search speed from 2, 4, 8, 16 times the normal speed.
7. **PLAY***
Press to activate the play mode while a disc is loaded in the disc compartment.

8. **SETUP**

Press to display the Setup Menu which allows the user to change the DVD player options such as TV DISPLAY, OSD LANGUAGE, PARENTAL CONTROL etc. Refer to the settings and adjustments section for more information.

9. **REPEAT**

Allow the user to repeat selected title, chapter or track.

10. **ZOOM**

Press this button to enlarge the picture when playing a DVD disc.

Press ZOOM button **DVD player perform**

Once	Enlarge the picture 1 times of the original size
Twice	Enlarge the picture 2 times of the original size
3 times	Enlarge the picture 3 times of the original size
4 times	Picture is returned to original size

11. **DVD Source****

This button is select key only can be active when remote control is in DVD mode function. Each time the button is pressed one of the source DVD, Card Reader and USB will be selected. If the Card Reader and USB not apply on the unit, it will remain on DVD Source.

12. **NUMBERS**

Allow the user to enter the numbers 0-9 for selection of the tracks, titles chapters or password setting.

13. **FMM ON/OFF Button**

Turns the FM Modulator power on/off.

14. **CHANNEL SELECT Button**

Selects the FM modulator Frequency (Frequency 1, 88.3MHz, Frequency 2, 88.7MHz, Frequency 3, 89.1MHz, Frequency 4, 89.5MHz, Frequency 5, 89.9MHz).

15. **DISC MENU**

Allow the user to access the disc menu.

16. **DISPLAY**

Press to display the current disc information while the disc is playing. Press the cursor (▲▼) buttons to select the Title or Chapter. For Title/Chapter selection use the numeric buttons to enter the desired Title Chapter selection.

17. **SUBTITLE**

Press to display and select the subtitle language in DVD mode. Each time you press the button, the subtitle language changes.

Note: *The type and number of languages for subtitle vary from disc to disc.*

18. **AUDIO**

Press to display and select Audio language in DVD mode. Each time you press the button, the language changes.

Note: *The available languages vary from disc to disc.*

19. **SCAN FORWARD (▶▶)**

Press to search in a forward direction. Press repeatedly to change the search Speed from 2, 4, 8, 16 times the normal speed.

20. **STOP (■)***

- Touch STOP once : (Stop) display perform to Stop playback, pressing the PLAY button again will resume normal playback.

- Touch STOP twice : (■ ■ Stop) display perform to stop playback.

21. **PAUSE (||)**

Press to pause playback.

22. **NEXT (▶▶)**

Press to skip to the next chapter or track.

23. PIX (Picture Select)

Each time this button is pressed, the on screen picture adjustment displays the "Adjustment bar" for BRIGHTNESS, CONTRAST, COLOR or TINT. Once the desired adjustment bar is displayed, use the VOLUME+/-VOLUME- button to adjust the setting. The display will automatically turn off if no adjustments are made within 6 seconds, or if any other button is pressed.

24. VOLUME DOWN (-)

Press to decrease the picture adjustments in the picture select mode.

25. VOLUME UP (+)

Press to increase the picture adjustments in the picture select mode.

26. Eject (▲) Button*

This button is used to eject the disc.

27. SOURCE*

Video signals from video equipment connected to the audio / video input can be displayed on the monitor by pressing this button. Each time the button is pressed, the audio/video source will switch between DVD and AUX.

SETTINGS AND ADJUSTMENTS

The Setup Menu contains features and options that let you customize your DVD player. For example, you can set a language for the on-screen display or prevent DVD playback for children.

Using the Setup Menu

1. Press the SETUP button on the remote. The Setup Menu appears on the screen as shown per diagram.
2. In order to set the desired option, move the highlight into the setup area using the cursor button ►.
3. After entering the setup area, highlight the desired option using the cursor button ▲ or ▼.
4. Press ► to move the highlight to the different options for the selected item. Press ▲ or ▼ to select the desired options, and then press ENTER to confirm the selection.
5. Repeat steps 3~4 to continue setting the options that reside on the same Setup Page.
6. To change to another Setup page, press ◀ until the highlight moves back to the icon on the top part of the Setup Menu. Then, repeat steps 2~5.

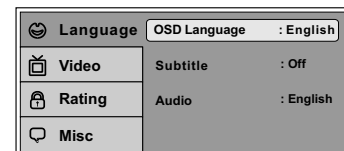

Exiting the Setup Menu

Press the SETUP button again only.

LANGUAGE SETUP

Language for On-Screen Display

OSD MENU: The OSD MENU setup allows you to select the language for the on-screen display. The user can either select English, French, Spanish, German or Italian for the OSD language.

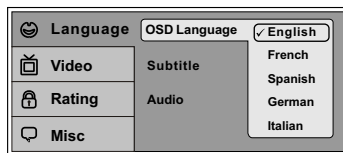

SUBTITLE SETUP

Select "SUBTITLE" using ▲▼button, then press ►button to enter the Sub menu. Select the subtitle you desire using ▲▼button, then press "ENTER" to confirm the setting. Press ◀button to return.

Note: The subtitle selection is only available for discs that are recorded in the above listed languages. If the selected, language is not available, the player will play and display on the screen the original language contained in the disc.

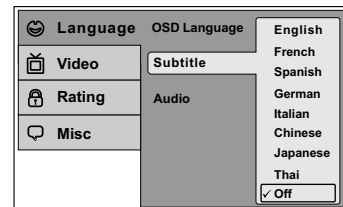

AUDIO SETUP

Select "AUDIO" using ▲▼button, then press ►button to enter the Sub menu. Select the audio you desire using ▲▼button, then press "ENTER" to confirm the setting. Press ◀button to return.

Note: The audio selection is only available for discs that are recorded in the above listed languages. If the selected, language is not available, the player will play and display on the screen the original language contained in the disc.

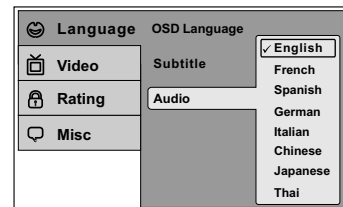

VIDEO SETUP

TV Display

The TV DISPLAY setup allows you to adjust screen setting (aspect ratio).

4:3

This displays the wide picture with black bands on the upper and lower portions of the screen.

16:9

This displays a wide picture with black bands on the upper and lower portion of the screen. The bandwidth will vary, depending on the aspect ratio of the disc.

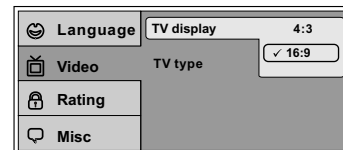

TV Type

The TV TYPE setup allows you to select the system to fit to the color system of the TV to be connected.

NTSC - Select this type for NTSC TV

PAL - Select this type for PAL TV

MULTI - Select this type for multi-system TV

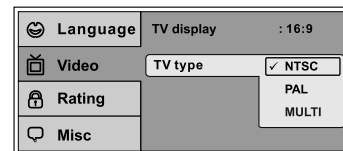

RATING SETUP

Rating

This item allows you to limit the content of movie playback from G to Adult. The lower the value, the more strict the control.

1. G
2. PG
3. PG – 13
4. R
5. NC – 17
6. Adult

The rating level can only be changed when the displayed lock is open. For first time use to change parental control, using cursor ► button to enter parental mode, key in the default password (3308) and press ENTER. Press ENTER button again to Select the parental level, select the level and press ENTER. To change the password to your own password press “Change Password” mode and enter the default password (3308) and press ENTER. Press ENTER button and again and key in a new four digit password. After complete press the rating level can only be changed when the displayed lock is open. For first time use to change parental control, using cursor ► button to enter parental mode, key in the default password (3308) and press ENTER. Press ENTER button again to button to end the process.

Note: The Default Password is 3308. This password is always effective even after you have selected your own password and changed it. To avoid the possibility of others using the default password to set the parental level and change the password, you can record this default password in another area and delete it from this manual. Some discs can be limited depending on the age of users while some discs cannot.

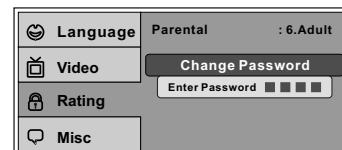
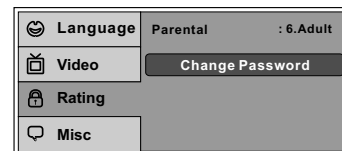

Misc SETUP

Select "MISC" using ▲▼button, then press ►button to enter the Misc menu. Select the subtitle you desire using ▲▼button, then press "ENTER" to confirm the setting. Press ◀button to return.

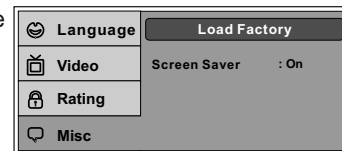

Load Factory

Load Factory allows you to reset all options to factory settings.

* This function will not affect the Rating control settings.

Screen Saver

ON -Screen saver will appear

OFF -Screen saver will not appear

Note: The DVD player will enable the Screen Saver mode if the unit is inactive for approximately 2 minutes.

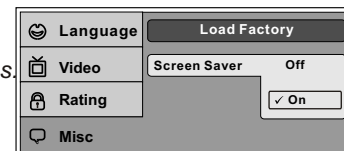
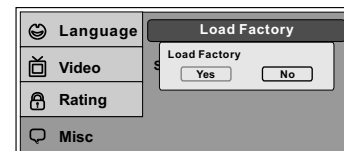

Playing DVDs

1. Press the DISPLAY button on the remote control to display the status banner. The banner includes title, chapter, angle, audio, subtitle and time.
2. **Title Selection**
Press numeric(0~9) buttons to initiate a change of title selection. Then press ENTER to implement the selection.
3. **Chapter selection**
Press numeric(0~9) buttons to initiate a change of chapter selection. Then press ENTER to implement the selection.

As you toggle through the options, the repeat option changes at that time. The track, for example, repeats once that track has ended. The selected repeat option loops repeatedly until you turn it off.

Playing MP3 Discs

MP3 is a format for storing digital audio. An audio CD-quality song can be compressed into the MP3 format with very little loss of quality, while taking up much less space. CD-R discs that have been encoded in MP3 format can be played on your DVD player. The DVD player plays the songs in the order they were burned on to the disc. When playback is started the elapsed time of the track that is playing will be displayed.

Selecting Folders and Songs

When a device containing MP3 files is loaded in the player, the navigation menu appears automatically.

1. Press ▲ or ▼ to move the highlight to the desired folder (if present) on the left side of the menu and press ENTER. The songs in the folder will be displayed on screen.
2. Press ▲ or ▼ to move the highlight to the desired track containing the song and Press ENTER to begin track playback.

Skipping Songs

Use the Next (▶▶) button on the remote control to move to the next song. Use the Previous (◀◀) button to move to the previous song.

Selecting a Play Mode

Filter (For MP3 & JPEG only)

Filter Mode enables or disables the display of files contained on the media based on their file extension.

The filter function applies to the following formats:

Audio - Audio data format (MP3, WMA)

Photo - Photo data format (JPEG)

Video - Video data format (MPEG I, II)

Flat Mode: play the entire disc

This mode is always on (default). During the Flat Mode, all the data folder with MP3, JPEG & movies will be played in sequence. If the Flat Mode function is off, it will only play the selected folder; other folders are disabled.

Repeat: play repetitively

Repeat function has 4 options : Off, Single, Folder, All. Move cursor to Repeat function and press ENTER, Off/Single/Folder/All are displayed in that order. Repeat default is Off;

- Off** Turn off repeat function
- Single** Repeat the song being played until STOP is pressed.
- Folder** Play all songs in a folder repetitively
- All** Play all songs on the disc repetitively

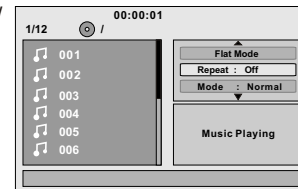
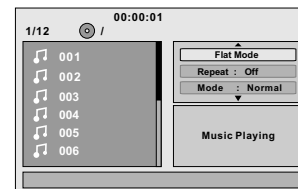
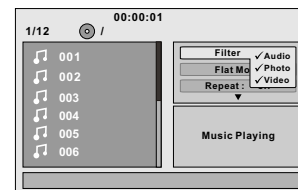

Mode: play mode

The Mode function has 4 options: Normal, Shuffle, Random and Music Intro. Move cursor to the desired Mode function and press ENTER; Normal/Shuffle/Random/Music Intro are selected in that order. The Mode function default status is Normal.

Normal: Play all songs in folder once

Shuffle: Play songs in a folder in a shuffle order. Each song in the folder is played only once.

Random: Play songs in a folder in a random order.

Music Intro: Play each song in order in the folder for 10 seconds

Remark– The purpose of the Music Intro function is to provide the user with a sample of each song for 10 seconds, thereby making it easy to select and listen to a favorite song.

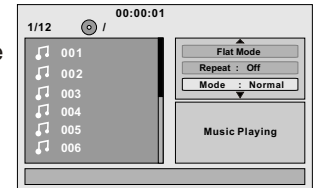

Add to program

Method: To add the selected songs into Browser view, make sure disc playback is off. Move cursor to Edit mode function and press ENTER. After Edit mode is selected, move cursor to songs list and select the songs which will be compiled and press ENTER. A check mark appears to the left of the selected song; to add the selected songs to the program, move cursor to the “Add to program” function and press ENTER. The selected songs is added into a new program list and the check mark will disappear on play list, move cursor to “Program view” function and press ENTER to browse the songs in the program. Press play button to play the selected songs.

Notice: Edit mode, Program view or Add to program functions are relationship related when select the preferred song add to the songs list.

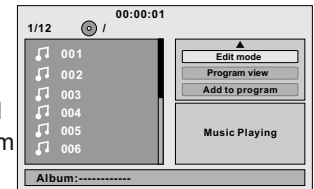

Clear program

Method: To clear the selected songs program file, double press stop button to the playback mode, move cursor to Edit mode function and press ENTER. After Edit mode is selected, move cursor to selected songs list and select the songs which you want to delete; press ENTER and a check mark will appears to the left of the selected song, move cursor to clear program and press ENTER, the selected songs will be deleted and disappear on the play list.

Notice: Edit mode, Browser view or Clear program functions are relationship related when delete the selected song at the songs list.

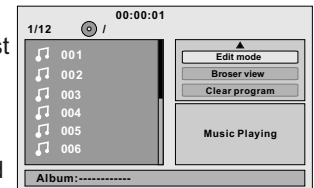

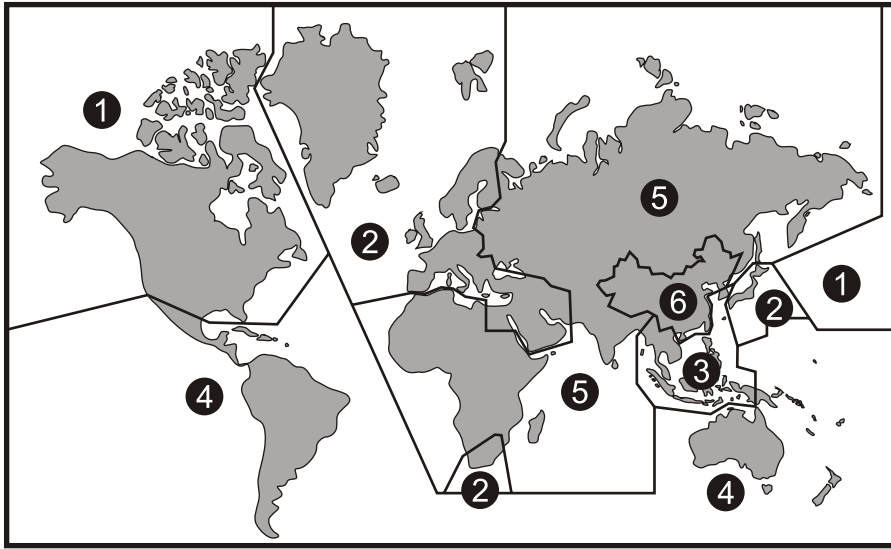

Region 1- USA, Canada

Region 2- Japan, Europe, South Africa, Middle East, Greenland

Region 3- S. Korea, Taiwan, Hong Kong, Parts of South East Asia

Region 4- Australia, New Zealand, Latin America (including Mexico)

Region 5- Eastern Europe, Russia, India, Africa

Region 6- China

DVD Area Code

The DVD player is preset to a region code at the factory depending on where the DVD player is sold. DVDs from a different region cannot be played in this unit and the unit will display "WRONG REGION"

DVD Basics

To get the optimum use out of the DVD section, make sure you read this section completely.

Types of Discs your DVD will play

- DVD* disc - DVD discs which contain video.
 - Audio discs - Audio CDs contain musical or sound content only.
 - MP3 discs - A disc that contains audio files (for example, a CD-R with downloaded MP3 files).
- * This system is capable of playing most recordable DVD formats. However, due to the variety of disc manufacturers and software, playback cannot be guaranteed.

Loading and Playing Discs

Before you load a disc, make sure that it is compatible with the player. Insert the disc with the label facing the headliner.

Note: *the following Discs **CANNOT** be used with this player :*

- *MiniDisc*
- *Laserdisc*
- *CD-1, CD-ROM, DVD-ROM, Super Audio CD (SACD), DVD Audio, JPEG*

To load and Play a Disc

Press the Power button to turn the unit ON. Select DVD mode and insert the disc (Label facing headliner) into the disc compartment.

ACCESSORIES

WIRELESS HEADPHONES

The ADV850S/P includes a built-in infrared transmitter for use with the supplied wireless headphones. The headphone volume is adjusted using the controls on each headset. Any number of wireless headphones may be used but they must be used within a line of sight from the transmitter, as infrared transmissions, like visible light travel only in a straight line. See the documentation accompanying your wireless headphones.

TROUBLESHOOTING

PROBLEM	SOLUTION
IR sensor inoperative	<ul style="list-style-type: none">• Verify that the batteries in the remote are fresh.• Verify that the remote sensor eye is not obstructed.
Disc won't play	<ul style="list-style-type: none">• Insert a disc with the label side facing up.• Check the type of disc you put into disc tray. This DVD only plays DVDs, audio CDs and MP3s.• Both the unit and the disc are coded by region. If the regional codes don't match, the disc can't be
Play starts, but then stops immediately	<ul style="list-style-type: none">• The disc is dirty. Clean it.• Condensation has formed. Allow player to dry out.
No sound or distorted sound	<ul style="list-style-type: none">• Make sure your DVD is connected properly. Make sure all cables are securely inserted into the appropriate jacks.• If you are using the IR headphones, make sure you turn on the IR headphone power.• Make sure the Modulator is ON and the proper Frequency has been selected.
Can't advance through a movie	<ul style="list-style-type: none">• You can't advance through the opening credits and warning information that appear at the beginning of movies because the disc is programmed to prohibit that action.

PROBLEM	SOLUTION
⊘ Not allowed at the moment	<ul style="list-style-type: none"> • The feature or action cannot be completed at this time because: <ol style="list-style-type: none"> 1. The disc's software restricts it. 2. The disc's software doesn't support the feature (e.g., angles) 3. The feature is not available at the moment. 4. You've requested a title or chapter number that is out of range.
Picture is distorted	<ul style="list-style-type: none"> • The disc might be damaged. Try another disc. • It is normal for some distortion to appear during forward or reverse scan.
No forward or reverse scan	<ul style="list-style-type: none"> • Some discs have sections that prohibit rapid scanning or title and chapter skip. • If you try to skip through the warning information and credits at the beginning of a movie, you won't be able to. This part of the movie is often programmed to prohibit skipping through it.
Infrared headphone inoperative	<ul style="list-style-type: none"> • Verify that the batteries in the infrared headphone are fresh. • Verify the unit infrared sensor eye is not obstructed. • To reset the IRT sensor eye back to normal operation, press the screen mode and Power on/off button in the same time (unit in standby mode) to restart the IRT mode program. • Press the IRT ON/OFF mode to turn on the

REPLACEMENT PARTS

Remote Control

136-4509

SPECIFICATIONS

Resolution	1440 x 234
Pixels	336, 960
Operation Temperature	32 ~131° F (0 ~ 55° C)
Storage Temperature	-4 ~ 176° F (-20 ~ 70° C)
Backlight life	10,000 Hours
Video Display System	NTSC/PAL
Video Output	1.0Vp-p @ 75 ohms
Power Source	12V DC
Dimensions	W X H X L 9.25 X 1.81 X 10.80 inches 235 X 46 X 275mm

Specifications subject to change without notice.



ADVENT LIMITED WARRANTY

Applies to ADVENT Mobile Video Products



AUDIOVOX ELECTRONICS CORP. (the Company) warrants to the original retail purchaser of this product that, should this product or any part thereof (except game controllers), under normal use and conditions, be proven defective in material or workmanship within 36 months from the date of original purchase, such defect(s) will be repaired or replaced with reconditioned product (at the Company's option) without charge for parts and repair labor.

If your new vehicle's radio, CD/DVD player is covered by the manufacturer's warranty for a period of 48 months as set forth in the OEM Warranty Booklet, the company will extend the Advent Mobile Video product warranty for the same period of time. This is not applicable to extended warranty purchases beyond the original manufacturer's warranty. A game controller, if supplied, is similarly warranted for ninety (90) days.

To obtain repair or replacement within the terms of this Warranty, the product is to be delivered with proof of warranty coverage (e.g. dated bill of sale), specification of defect(s), transportation prepaid, to the Company at the address shown below.

This Warranty does not extend to the elimination of externally generated static or noise, to correction of antenna problems, to costs incurred for installation, removal or reinstallation of the product, or to damage to digital memory/media devices, gaming devices, discs, speakers, accessories, or vehicle electrical systems.

This Warranty does not apply to any product or part thereof which, in the opinion of the Company, has suffered or been damaged through alteration, improper installation, mishandling, misuse, neglect, accident, or by removal or defacement of the factory serial number/bar code label(s). THE EXTENT OF THE COMPANY'S LIABILITY UNDER THIS WARRANTY IS LIMITED TO THE REPAIR OR REPLACEMENT PROVIDED ABOVE AND, IN NO EVENT, SHALL THE COMPANY'S LIABILITY EXCEED THE PURCHASE PRICE PAID BY PURCHASER FOR THE PRODUCT.

This Warranty is in lieu of all other express warranties or liabilities. ANY IMPLIED WARRANTIES, INCLUDING ANY IMPLIED WARRANTY OF MERCHANTABILITY, SHALL BE LIMITED TO THE DURATION OF THIS WRITTEN WARRANTY. ANY ACTION FOR BREACH OF ANY WARRANTY HEREUNDER INCLUDING ANY IMPLIED WARRANTY OF MERCHANTABILITY MUST BE BROUGHT WITH IN A PERIOD NOT EXCEEDING 12 MONTHS AFTER EXPIRATION OF THE WARRANTY. IN NO CASE SHALL THE COMPANY BE LIABLE FOR ANY CONSEQUENTIAL OR INCIDENTAL DAMAGES FOR BREACH OF THIS OR ANY OTHER WARRANTY. No person or representative is authorized to assume for the Company any liability other than expressed herein in connection with the sale of this product.

Some states do not allow limitations on how long an implied warranty lasts or the exclusion or limitation of incidental or consequential damage so the above limitations or exclusions may not apply to you. This Warranty gives you specific legal rights and you may also have other rights which vary from state to state.

Audiovox Electronics Corporation, 150 Marcus Blvd., Hauppauge, New York 11788 • 1-800-645-4994

128-7188B

NOTES

NOTES

