

**ADV10  
10.1" OVERHEAD LCD  
MONITOR WITH  
DVD PLAYER**

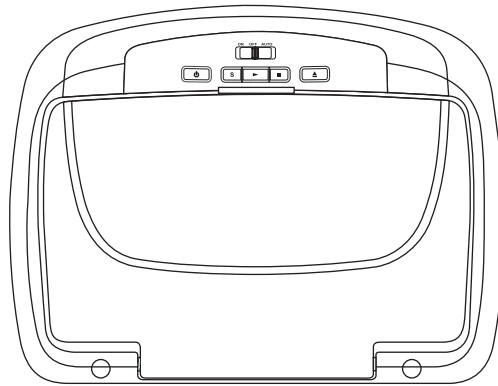

**///ADVENT®**

**OPERATION  
MANUAL**

128-8567C

## Important Notice

Installation of overhead products requires careful planning and preparation. Be extremely careful when working on a vehicle with side curtain air bags. Do not route wires near any portion of the side curtain air bag assemblies. This includes any anchor points in A, B, C or D pillars of the vehicle. Routing wires in these areas or running wires by the side curtain air bags can prevent the side curtain air bag from fully deploying which can result in personal injury to vehicle occupants. If you have any questions regarding wire routing in a vehicle, please contact Audiovox Technical Support at 1-800-225-6074.

When connecting power and ground in a mobile video installation ensure that the ACC wire is fused at the point where it is connected to the vehicle ACC wiring. Failure to do so can result in damage to the vehicle if a short circuit develops between the vehicle connection point and the mobile video product.

An LCD panel and/or video monitor may be installed in a motor vehicle and visible to the driver if the LCD panel or video monitor is used for vehicle information, system control, rear or side observation or navigation. If the LCD panel or video monitor is used for television reception, video or DVD play, the LCD panel or video monitor must be installed so that these features will only function when the vehicle is in "park" or when the vehicle's parking brake is applied.

An LCD panel or video monitor used for television reception, video or DVD play that operates when the vehicle is in gear or when the parking brake is not applied must be installed to the rear of the driver's seat where it will not be visible, directly or indirectly, to the operator of the motor vehicle.

## Warnings

- Do not use any solvents or cleaning materials when cleaning the video monitor.
- Do not use any abrasive cleaners, they may scratch the screen.
- Use only a lightly dampened lint free cloth to wipe the screen if it is dirty.
- Lock the LCD screen in the fully closed position when not in use.
- Before putting on headphones always adjust the volume setting to the lowest position.
- Remember to leave the dome light switch in the off or auto positions when the vehicle is unattended, as the dome lights, if left on, can drain the vehicle's battery.
- Do not put pressure on the screen.
- Caution children to avoid touching or scratching the screen, as it may become dirty or damaged.

Licensed under one or more of the following patents,  
Patent NOS. 5,775,762 , 5,927,784 and 6,678,892

## Congratulations

Congratulations on your purchase of the ADVENT ADV10 DVD Player with drop-down video / monitor. The ADV10 has been designed to give you and your family many years of video entertainment in the mobile environment. Please read the directions that follow to familiarize yourself with the product to ensure that you obtain the best results from your equipment.

**Note:** *Installation options vary, see the individual owner's manuals for each component in your system to obtain a full understanding of each component's operation.*

## Safety Precaution

For safety reasons, when changing video media it is recommended that the vehicle is not in motion, and that you do not allow children to unfasten seat-belts to change video media or make any adjustments to the system. System adjustments can be accomplished using the remote control, while seat-belts remain fastened. Enjoy your ADVENT entertainment system but remember the safety of all passengers remains the number one priority.

## FEATURES

- 10.1" TFT (Thin Film Transistor) Active Matrix LCD (Liquid Crystal Display) Monitor
- Built-in DVD Player
- OSD (On Screen Display) for Control of Picture Quality and Functions
- Infrared Transmitter for IR wireless headphones
- Two Audio / Video Source Inputs (DVD, AV1/AUX)
- Dome lights with built-in three way switch
- Built-in 16 Channel Wireless FM Modulator
- Last Position Memory for DVD
- Screen Mode selection (4:3, 16:9)
- Full Function Remote Control
- Backlit Controls
- AV output via RCA Jacks
- Playing DVD, CD and MP3 discs

## CONTROLS AND INDICATORS DIAGRAM (FRONT VIEW)

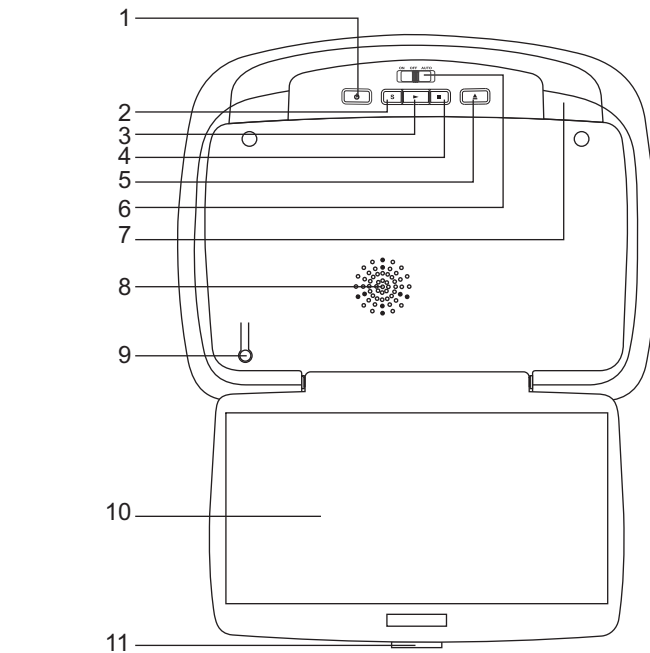

- 1. POWER (⏻) Control**  
Used to turn the system on/off (standby).
- 2. Source Select (S)**  
Use to select one of the two sources: DVD, AV1/AUX
- 3. PLAY (▶) Control**  
This control is used to start playback of a disc.

- 4. STOP (■) Control**
  - Press STOP once : Stops playback, Pressing the PLAY button again will resume normal playback from where movie was stopped.
  - Press STOP twice and then press PLAY to start playback from the beginning of the DVD.
- 5. EJECT (▲) Control**  
This control is used for ejecting disc from the disc compartment.
- 6. Three Position Dome Light Switch**
  - ON** - Turns on the dome lights.
  - OFF** - The dome lights will not turn on in this position.
  - AUTO** - Automatically switches on the dome lights in conjunction with the vehicle's interior illumination.
- 7. Dome Lights**  
Provide additional interior illumination.
- 8. Ventilation Openings**
- 9. LCD Cut Off Switch**  
Used to turn off the LCD backlight when the LCD is in the closed position.
- 10. LCD Panel**
- 11. Screen Release**  
Press to release the screen.

## CONTROL FUNCTION DESCRIPTION (SIDE VIEW)

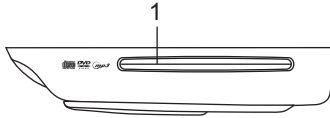

- 1. DVD Disc insertion Slot**  
For loading and removing discs.

## CONTROL FUNCTION DESCRIPTION (BACK VIEW)

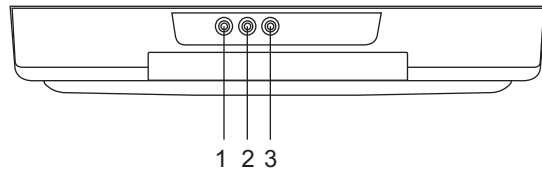

- 1. Auxiliary Video Input**
- 2. Auxiliary Audio Left Input**
- 3. Auxiliary Audio Right Input**

## REMOTE CONTROL OPERATION

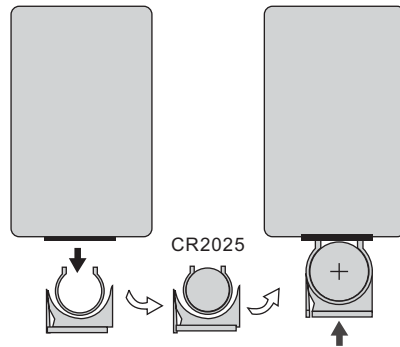

### **Initial Use**

When purchased the remote control has a battery installed with a Pull Tab to prevent battery discharge. Remove the Pull Tab before attempting to use the remote.

### **Battery Replacement**

1. Remove the battery holder.
2. Insert the battery into the battery holder and insert the battery holder into the remote. Be sure to observe the correct polarity.
3. Align the battery holder with the remote control and push it in until the holder clicks.

## MAIN FUNCTION OPERATION

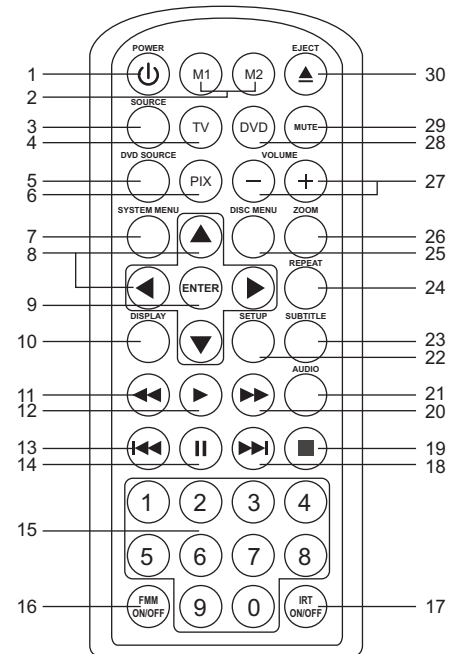

\* Function control is available on the unit and the Remote Control.

\*\* Function not available in this model.

**1. POWER\***

Press this button to turn the unit ON and OFF.

**2. MONITOR SELECT**

**M1 Button** – Set the remote control code to allow control of the unit in M1 mode.

**M2 Button\*\*** – Set the remote control code to allow control of the unit in M2 mode.

**3. SOURCE\***

Each time the button is pressed, the unit will cycle through modes DVD, AV1/AUX

**4. TV Mode Select**

Switches certain function keys on the remote control for monitor functions.

**5. DVD Source**

This button is only active when remote control is in DVD mode.

**6. PIX ( Picture Select )**

Each time of this button is pressed, the OSD picture adjustment displays the "Adjustment bar" for BRIGHTNESS, CONTRAST, COLOR, TINT(For NTSC only) or RESET. Once the desired adjustment bar is displayed, use the VOLUME+/-VOLUME- button to adjust the setting. The display will automatically turn off if no adjustments are made within 6 seconds.

**7. SYSTEM MENU**

Allow the user to access the system menu when the unit has been placed in TV mode ( See Item number 4 ). Press cursor (▲▼) buttons to select desired picture control FMM screen mode, OSD language and source default during power up.

**8. CURSOR (▲▼◀▶)**

Use these buttons to access menu selections on the screen.

**9. ENTER**

Used to implement a selected setting or menu option.

**10. DISPLAY**

Press to display the current disc information while the disc is playing. Press the cursor (▲▼) buttons to select the Title or Chapter. For Title/Chapter selection use the numeric buttons to enter the desired Title /Chapter selection.

**11. SCAN BACKWARD (◀◀)**

Press to search in a backward direction. Press repeatedly to change the search speed from 2, 4, 8, 16 times and normal speed.

**12. PLAY\***

Press to activate the play mode while a disc is loaded into the disc compartment.

**13. PREVIOUS (◀◀)**

Press to return to the previous chapter or track.

**14. PAUSE (||)**

Press to pause playback.

**15. NUMBERS**

Allow the user to ENTER the numbers 0-9 for selection of the tracks, titles chapters or password setting.

**16. FMM ON/OFF**

Turns the FM Modulator power on/off.

**17. IRT ON/OFF (Optional)**

Turns the Infrared Transmitter on or off for IR wireless headphones.

**18. NEXT (▶▶)**

Press to skip to the next chapter or track.



**19. STOP (■)\***

Press to stop playback.(Playback will resume from the point it is stopped).

Press twice at once to stop playback fully. (Playback will resume from the beginning of the disc).

**20. SCAN FORWARD (▶▶)**

Press to search in a forward direction. Press repeatedly to change the search speed from 2, 4, 8, 16 times and normal speed.

**21. AUDIO**

Press to display and select audio language in DVD mode. Each time you press the button, the language changes.

*Note: The available languages vary from disc to disc.*

**22. SETUP**

Press to display the Setup menu which allows the user to change the DVD player options such as LANGUAGE, VIDEO, RATING & MISC.

*Note: The unit must be set to DVD mode by pressing the DVD button prior to pressing the SETUP button.*

**23. SUBTITLE**

Press to display and select the subtitle language in DVD mode. Each time you press the button, the subtitle language changes.

*Note: The type and number of languages for subtitle vary from disc to disc.*

**24. REPEAT**

Allows the user to repeat a selected title, chapter, or track.

**25. DISC MENU**

Allow the user to access the disc's menu mode.

**26. ZOOM**

Press this button to enlarge the picture when playing a DVD disc.

**Press ZOOM button**

**DVD player perform**

Once

Q1- Enlarge the picture 2 times of the original size

Second

Q2- Enlarge the picture 3 times of the original size

Third

Q3- Enlarge the picture 4 times of the original size

Forth

Q off- Picture is returned to original size

**27. VOLUME DOWN (-) or UP (+)**

Press to decrease or increase the level of the picture adjustments after the picture select button (PIX) is pressed.

**28. DVD Mode Select Button**

Switches certain function keys on the remote control for DVD function.

**29. MUTE**

Press this button to mute the audio for wireless FMM, IR headphones and wired headphones.

Pressing the button again restores the audio to the previously set level.

**30. EJECT (▲)\***

This button is used to eject the disc.

## SYSTEM MENU ADJUSTMENTS

The System Menu Contains features and options that let you customize your system to change the screen mode display, OSD language and source default.

- 1) Press the TV button and then the SYSTEM MENU button on the remote, the main page of the system menu will appear on screen.
- 2) Use the cursor buttons ▲ or ▼ to select the desired item in the main page and press the ENTER button to select.
- 3) The submenu will appear on screen.
- 4) Use the cursor buttons ▲ or ▼ to select an item in the sub menu and then press the ENTER button to select.
- 5) Press the System Menu button to exit System Menu.

**Note:** System Menu can be controlled via Remote Control only. (Items selected in the menu will have a green background)

### PICTURE CONTROL SELECT

When watching a program, the picture quality can be adjusted to the user's references.

- 1) Press the SYSTEM MENU button on the remote and the on screen picture adjustment displays the "adjustment" for **BRIGHTNESS**, **CONTRAST**, **COLOR**, **TINT** (for NTSC only) or **RESET**.
- 2) Use the cursor buttons ▲ or ▼ to highlight PICTURE CONTROL and press ENTER. The PICTURE CONTROL menu will be displayed.
- 3) Use the cursor buttons ▲ or ▼ to select the desired adjustment and press ENTER.
- 4) Use the cursor buttons ▲ or ▼ or the +or - buttons to change the settings. Press ENTER when the adjustment is finished.

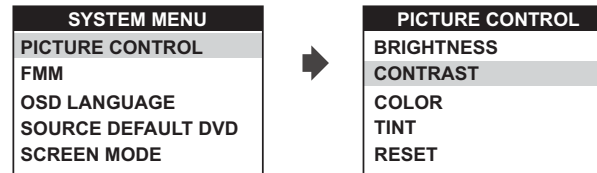

### **FMM SELECT**

FMM ON/OFF options - Turns the wireless FM Modulator on or off.

FMM SELECT option - Selects the wireless FM Modulator Frequency (CH1 88.1MHz, CH2 88.3MHz, CH3 88.5MHz, CH4 88.7MHz, CH5 88.9MHz, CH6 89.1MHz, CH7 89.3MHz, CH8 89.5MHz, CH9 89.7MHz, CH10 89.9MHz, CH11 90.1MHz, CH12 90.3MHz, CH13 90.5MHz, CH14 90.7MHz, Ch15 90.9MHz, CH16 91.1MHz)

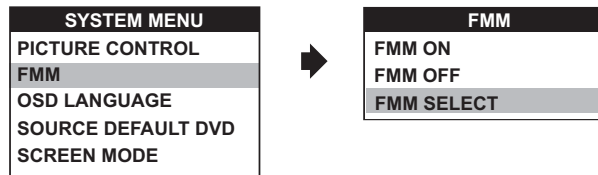

### **OSD LANGUAGE**

This function allows the user to select the language for the on-screen display.

The user can either select English, Spanish, French or German for the OSD language.

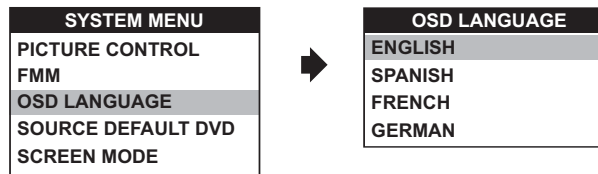

### **SOURCE DEFAULT DVD**

This allows the user to set the system default source to DVD.

#### **Note:**

- If source default is set to ON, every time the unit is turned off then on, the unit will power up and automatically switch the source to DVD. If source default is set to OFF and the unit is turned off then on, the unit will power up in whatever source was last selected.
- Unit is set to source default DVD on as the default mode of operation.
- Selection of Source default can only be made from within the system menu.

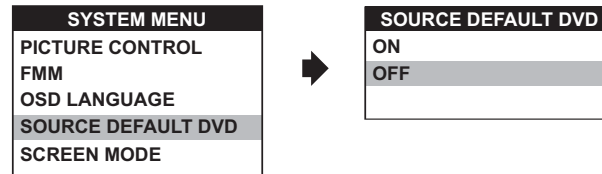

### **SCREEN MODE SELECT**

This allows the user to change the screen format (aspect ratio 4:3, 16:9).

To select the screen aspect ratio format highlight SCREEN MODE and press ENTER button to access the submenu. Then press the Cursor button ▲ or ▼ to select from 4:3 or 16:9. Press ENTER button to confirm the setting.

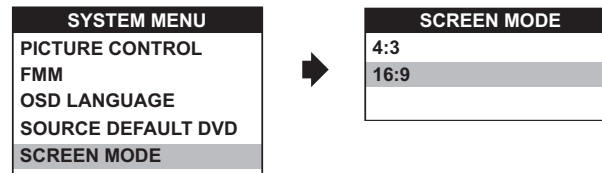

## DVD SETTINGS AND ADJUSTMENTS

The DVD Setup Menu contains features and options that let you customize your DVD player. For example, you can set a language for the on-screen display or prevent children from viewing DVD playback of adult DVD Titles.

### Using the Setup Menu

1. Press the DVD button and then the SETUP button on the remote. The Setup Menu appears on the screen as shown per diagram.
2. Use the ▲ or ▼ cursor buttons to highlight the settings to be changed. Use the ► cursor button to highlight the sub-settings. Press ► cursor button to open the submenu that contains the different options available. Press the ENTER button to set the desired option.
3. Use ◀ cursor button to position the highlight back on the icon side of the setup page to set the other options. Repeat steps 1~2.

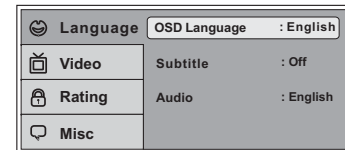

### Exiting the Setup Menu

Press the SETUP button again.

## LANGUAGE SETUP

### DVD Language for On-Screen Display

OSD MENU: The OSD MENU setup allows you to select the language for the on-screen display. The user can either select English, French, Spanish, German or Italian for the OSD language.

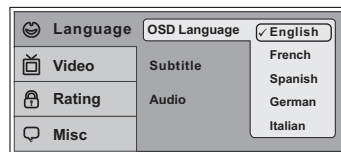

## DVD SUBTITLE SETUP

Select "SUBTITLE" using ▲▼button, then press ►button to enter the submenu. Select the subtitle you desire using ▲▼button, then press "ENTER" to confirm the setting. Press ◀button to return.

*Note: The subtitle selection is only available for discs that are recorded in the above listed languages. If the selected, language is not available, the player will play and display on the screen the original language contained in the disc.*

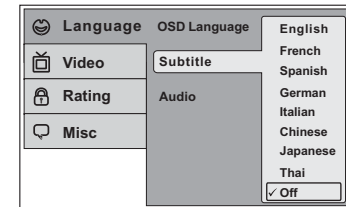

## DVD AUDIO SETUP

Select "AUDIO" using ▲▼button, then press ►button to enter the submenu. Select the audio language you desire using ▲▼button, then press "ENTER" to confirm the setting. Press ◀button to return.

*Note: The audio language selection is only available for discs that are recorded in the listed languages. If the selected, language is not available, the player will play and display on the screen the original language contained in the disc.*

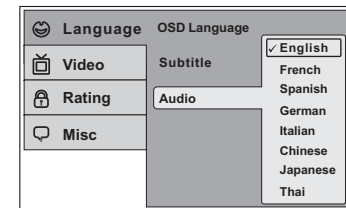

## DVD VIDEO SETUP

### **TV Display**

The TV DISPLAY setup allows you to set the screen aspect ratio.

4:3

This displays the wide picture with black bands on the upper and lower portions of the screen.

16:9

This displays a wide picture with black bands on the upper and lower portion of the screen. The band width will vary, depending on the aspect ratio of the disc.

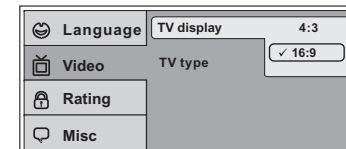

### **DVD TV Type**

The TV Type setup allows you to select the television standard which corresponds to your TV.

NTSC - Select this type for NTSC TV

PAL - Select this type for PAL TV

MULTI - Select this type for multi-system TV

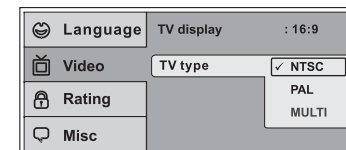

## DVD RATING SETUP

### **Parental**

This item allows you to limit the content of movie playback from G to Adult. The lower the value, the more strict the control.

1. G
2. PG
3. PG – 13
4. R
5. NC – 17
6. Adult

The rating level can only be changed when the correct password is provided. For first time use to change parental control, using cursor ► button to enter parental mode, key in the default password (3308) and press ENTER. Press ENTER button again to select the parental level, select the level and press ENTER.

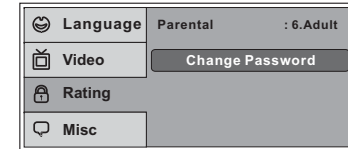

### **Change Password**

To change the password to your own password select “Change Password” mode and enter the default password (3308) followed by pressing ENTER. Press ENTER button again and key in a new four digit password.

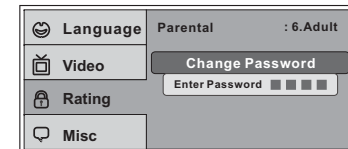

**Note:** The Default Password is 3308. This password is always effective even after you have selected your own password and changed it. To avoid the possibility of others using the default password to set the parental level and change the password, you can record this default password in another area and delete it from this manual. Some discs can be limited depending on the age of users while some discs cannot.

## DVD Misc SETUP

Select "MISC" using ▲▼ button, then press ► button to enter the Misc menu. Select the option you want to change using ▲▼ button, then press ENTER.

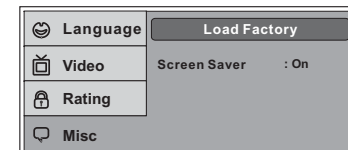



### Load Factory

This option allows you to reset all options to factory settings.

\* This function will not affect the Rating control settings.

### Screen Saver

This option allows you to set the Screen saver mode.

ON -Screen saver will appear

OFF -Screen saver will not appear

*Note: The DVD player will enter Screen Saver mode if the unit is inactive for approximately 2 minutes.*

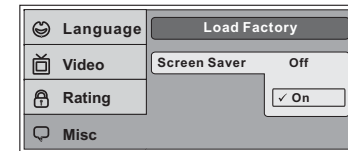
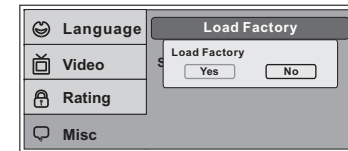

### Playing DVDs

1. Press the DISPLAY button on the remote control to display the status banner. The banner includes title, chapter, angle, audio, subtitle and time.

2. **Title Selection**

Press numeric(0~9) buttons to initiate a change of title selection. Then press ENTER to implement the selection.

3. **Chapter selection**

Press numeric(0~9) buttons to initiate a change of chapter selection. Then press ENTER to implement the selection.

## **Playing MP3 Discs**

MP3 is a format for storing digital audio. An audio CD-quality song can be compressed into the MP3 format with very little loss of quality, while taking up much less space. CD-R discs that have been encoded in MP3 format can be played on DVD player. The DVD player plays the songs in the order they were burned on to the disc. When playback is started the elapsed time of the track that is playing will be displayed.

## **Selecting Folders and Songs**

When a device containing MP3 files is loaded in the player, the navigation menu appears automatically.

1. Press ▲ or ▼ to move the highlight to the desired folder (if present) on the left side of the menu and press ENTER. The songs in the folder will be displayed on screen.
2. Press ▲ or ▼ to move the highlight to the desired track containing the song and press ENTER to begin track playback.

## **Skipping Songs**

Use the Next (▶) button on the remote control to move to the next song. Use the Previous (◀) button to move to the previous song.

## **Selecting a Play Mode**

### **Filter (For MP3 & JPEG only)**

Filter Mode enables or disables the display of files contained on the media based on their file extension.

The filter function applies to the following formats:

**Audio** - Audio data format (MP3, WMA)

**Photo** - Photo data format (JPEG)

**Video** - Video data format (MPEG I, II)

### **Flat Mode: play the entire disc**

This mode is always on (default). During the Flat Mode, all the data folder with MP3, JPEG and movies will be played in sequence. If the Flat Mode function is off, it will only play the selected folder; other folders are disabled.

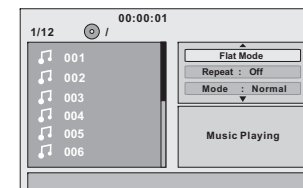
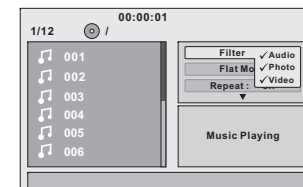

### Repeat: play repetitively

Repeat function has 4 options : Off, Single, Folder, All. Move cursor to Repeat function and press ENTER, Each time ENTER is pressed the unit will cycle through the available options. Off/Single/Folder/All are displayed in that order. Repeat default is Off;

- Off** Turn off repeat function
- Single** Repeat the song being played until STOP is pressed.
- Folder** Play all songs in a folder repetitively
- All** Play all songs on the disc repetitively

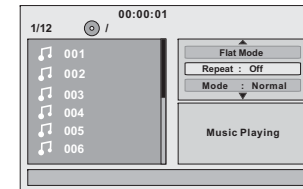

### Mode: play mode

The Mode function has 4 options: Normal, Shuffle, Random and Music Intro. Move cursor to the Mode function area and press ENTER repeatedly till the desired mode is displayed. Normal/Shuffle/Random/Music Intro are displayed in that order. The Mode function default is Normal.

- Normal:** Play all songs in folder once.
- Shuffle:** Play songs in a folder in a shuffle order. Each song in the folder is played only once.
- Random:** Play songs in a folder in a random order. Each song in a folder is't only be played once.
- Music Intro:** Play each song in order in the folder for 10 seconds

**Remark-** The purpose of the Music Intro function is to provide the user with a sample of each song for 10 seconds, thereby making it easy to select and listen to a favorite song.

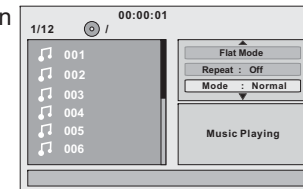

### Add to program

**Method:** To add the selected songs into Browser view, make sure disc playback is off. Move cursor to Edit mode function and press ENTER. After Edit mode is selected, move cursor to songs list and select the songs which will be compiled and press ENTER. A check mark appears to the left of the selected song; to add the selected songs to the program, move cursor to the "Add to program" function and press ENTER. The selected songs is added into a new program list and the check mark will disappear on play list, move cursor to "Program view" function and press ENTER to browse the songs in the program. Press play button to play the selected songs.

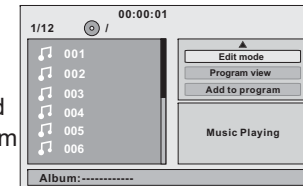

### Clear program

**Method:** To clear the selected song files, press the STOP button twice during playback mode. Move the cursor to the Edit mode function and press ENTER. After Edit mode is selected, move cursor to selected songs list and select the songs which you want to delete. Press ENTER and a check mark will appear to the left of the selected song. Move the cursor to clear program and press ENTER, the selected songs will be deleted from the play list.

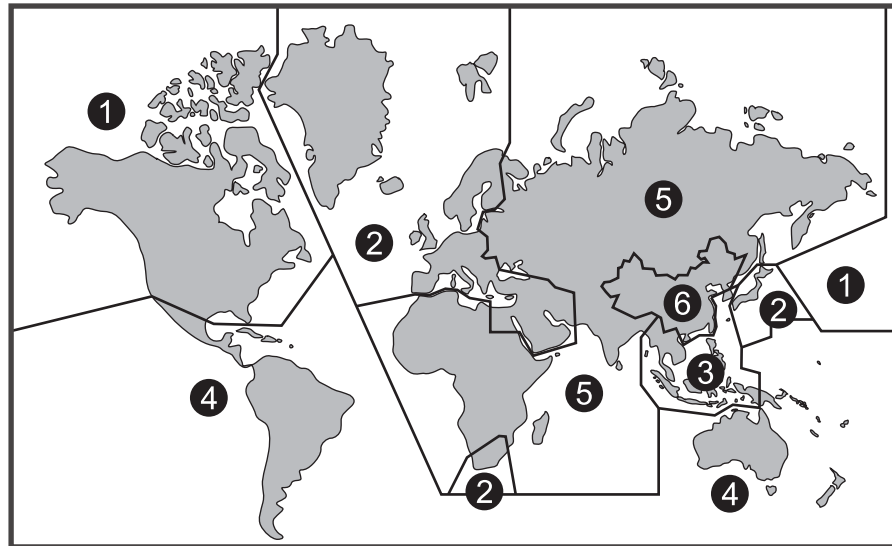
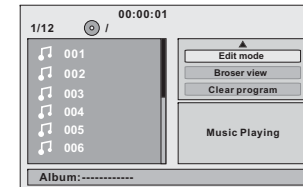

Region 1- USA, Canada

Region 2- Japan, Europe, South Africa, Middle East, Greenland

Region 3- S. Korea, Taiwan, Hong Kong, Parts of South East Asia

Region 4- Australia, New Zealand, Latin America (including Mexico)

Region 5- Eastern Europe, Russia, India, Africa

Region 6- China

### **DVD Area Code**

The DVD player is preset to a region code at the factory depending on where the DVD player is sold. A DVD from a different region cannot be played in this unit and the unit will display "WRONG REGION"

### **DVD Basics**

To get the optimum use out of the DVD section, make sure you read this section completely.

### **Types of Discs your DVD will play**

- DVD\* disc - DVD discs which contain video.
- Audio disc - Audio CDs contain musical or sound content only.
- MP3 disc - A disc that contains audio files (for example, a CD-R with downloaded MP3 files).

\* This system is capable of playing most recordable DVD formats. However, due to the variety of disc manufacturers and software, playback cannot be guaranteed.

### **Loading and Playing Discs**

Before you load a disc, make sure that it is compatible with the player. Insert the disc with the label facing the vehicle's headliner.

**Note:** the following Discs **CANNOT** be used with this player :

- MiniDisc
- Laserdisc
- CD-1, CD-ROM, DVD-ROM, Super Audio CD (SACD), DVD Audio, JPEG

### **To load and Play a Disc**

Press the Power button to turn the unit on. Select DVD mode and insert the disc (label facing upwards) into the disc compartment.

## TURNING THE UNIT ON OR OFF

1. Pushing in the Screen Release button will unlock the LCD screen and it will drop down slightly. Pivot the screen downward until a comfortable viewing angle is reached. The hinge friction will hold the screen in position while the system is in use.
2. Pressing the power button\* on the unit or the remote control will turn the system on and off. When in use the internal backlighting will illuminate the controls.
3. After the unit has been turned on and is displaying a picture, adjust the viewing angle, by pivoting the screen to optimize the picture quality.
4. Remember to turn the unit off and pivot the LCD to the locked position when not in use.

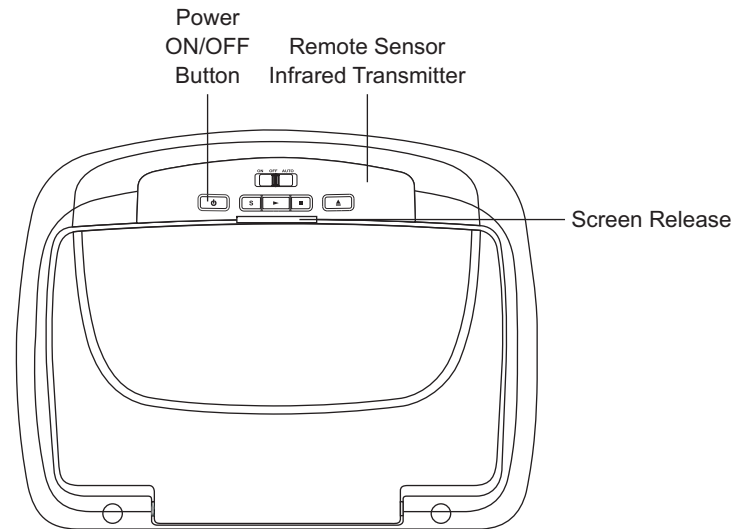

## **OVERHEAD DOME LIGHTS**

The Dome Lights integrated into the unit are controlled by a three position slide switch. Sliding the switch to the ON position will turn the lights ON. The OFF position will prevent the lights from turning ON with the vehicle's interior lighting, and the auto position will allow the lights to turn ON and OFF with the vehicle's interior lighting. Refer to the Installation Guide for wire connections. Do not leave the vehicle unattended with the dome light switch in the ON position, as this could result in a discharged battery.

## **ACCESSORIES**

### **WIRELESS HEADPHONES**

The ADV10 includes a built-in infrared transmitter for use with the supplied wireless headphones. The headphone volume is adjusted using the controls on each headset. Any number of wireless headphones may be used but they must be used within a line of sight from the transmitter, as infrared transmissions, like visible light travel only in a straight line. See the documentation accompanying your wireless headphones.

## **SOURCE FEATURE**

### **AV1**

The AV1 input may be connected to an external video source, video game system, or other audio / video devices. To access the audio / video inputs, turn the unit on and press the S (source) button or the Source button on the remote control until "AV1/AUX" is displayed on the screen. Turn the video source component on with its power button or remote control and it is now ready to play the audio and video signals from the source connected to AV1.

### **AUX**

The unit will accept an audio / video input through the 3 RCA jacks located on the rear of the unit. The audio / video device could be a video game system, video camera, or other input device. To access the audio / video inputs, turn the unit on and press the S (source) button or the Source button on the remote control until "AV1/AUX" is displayed on the screen. Turn the video source component on with its power button or remote control and it is now ready to play the audio and video signals from the source connected to AV1. The same time AV1 video and audio will be cutoff.

### **AV Out**

The unit provides an AV output for optional video monitor(s). This output will provide the AV signals that duplicate the picture/audio being processed by the unit to an additional monitor or video display. Please see your installer for more information.

## TROUBLESHOOTING

PROBLEM	SOLUTION
IR remote inoperative	<ul style="list-style-type: none"> <li>• Verify that the batteries in the remote are fresh.</li> <li>• Verify that the remote sensor eye is not obstructed.</li> </ul>
Disc won't play	<ul style="list-style-type: none"> <li>• Insert a disc with the label side facing upwards.</li> <li>• Check the type of disc you put into disc tray. This DVD only plays DVD, audio CD and MP3.</li> <li>• Both the unit and the disc are coded by region. If the regional codes don't match, the disc can't be played.</li> </ul>
Play starts, but then stops immediately	<ul style="list-style-type: none"> <li>• The disc is dirty. Clean it.</li> <li>• Condensation has formed. Allow player to dry out.</li> </ul>
No sound or distorted sound	<ul style="list-style-type: none"> <li>• Make sure your DVD is connected properly. Make sure all cables are securely inserted into the appropriate jacks.</li> <li>• If you are using the 2-channel IR headphones, make sure you turn on the IR headphone power, make sure the correct channel (A-B) is selected.</li> <li>• Make sure the Modulator is ON and the proper Frequency has been selected.</li> <li>• Make sure that unit is set to M1 when using Single Channel Headphones.</li> </ul>
Can't advance through a movie	<ul style="list-style-type: none"> <li>• It can't advance through the opening credits and warning information that appear at the beginning of movies because the disc is programmed to prohibit that action.</li> </ul>



PROBLEM	SOLUTION
⊘ Not allowed at the moment	<ul style="list-style-type: none"> <li>• The feature or action cannot be completed at this time because:               <ol style="list-style-type: none"> <li>1. The disc's software restricts it.</li> <li>2. The disc's software doesn't support the feature (e.g., angles)</li> <li>3. The feature is not available at the moment.</li> <li>4. 4 requested a title or chapter number that is out of range.</li> </ol> </li> </ul>
Picture is distorted	<ul style="list-style-type: none"> <li>• The disc might be damaged. Try another disc.</li> <li>• It is normal for some distortion to appear during forward or reverse scan.</li> </ul>
No forward or reverse scan	<ul style="list-style-type: none"> <li>• Some discs have sections that prohibit rapid scanning or title and chapter skip.</li> <li>• If you try to skip through the warning information and credits at the beginning of a movie, you won't be able to. This part of the movie is often programmed to prohibit skipping through it.</li> </ul>

**REPLACEMENT PARTS**

Remote Control

136-4840

**SPECIFICATIONS**

LCD Backlighting	LED
Resolution	800 (RGB) x 480
Pixels	1,152,000
Operation Temperature	32 ~131° F (0 ~ 55° C)
Storage Temperature	-4 ~ 158° F (-20 ~ 70° C)
Backlit life	10,000 Hours
Video Display System	NTSC / PAL
Video Output	1.0 Vp-p @ 75 ohms
Power Source	12 VDC
Dimension	L x W x H
	11.0" x 9.5" x 1.7"
	289mm x 243mm x 44mm

Specifications are subject to change without notice.



**ADVENT LIMITED WARRANTY**  
*Applies to ADVENT Mobile Video Products*



AUDIOVOX ELECTRONICS CORP. (the Company) warrants to the original retail purchaser of this product that, should this product or any part thereof (except game controllers), under normal use and conditions, be proven defective in material or workmanship within 36 months from the date of original purchase, such defect(s) will be repaired or replaced with reconditioned product (at the Company's option) without charge for parts and repair labor.

If your new vehicle's radio, CD/DVD player is covered by the manufacturer's warranty for a period of 48 months as set forth in the OEM Warranty Booklet, the company will extend the Advent Mobile Video product warranty for the same period of time. This is not applicable to extended warranty purchases beyond the original manufacturer's warranty. A game controller, if supplied, is similarly warranted for ninety (90) days.

To obtain repair or replacement within the terms of this Warranty, the product is to be delivered with proof of warranty coverage (e.g. dated bill of sale), specification of defect(s), transportation prepaid, to the Company at the address shown below.

This Warranty does not extend to the elimination of externally generated static or noise, to correction of antenna problems, to costs incurred for installation, removal or reinstallation of the product, or to damage to digital memory/media devices, gaming devices, discs, speakers, accessories, or vehicle electrical systems.

This Warranty does not apply to any product or part thereof which, in the opinion of the Company, has suffered or been damaged through alteration, improper installation, mishandling, misuse, neglect, accident, or by removal or defacement of the factory serial number/bar code label(s). THE EXTENT OF THE COMPANY'S LIABILITY UNDER THIS WARRANTY IS LIMITED TO THE REPAIR OR REPLACEMENT PROVIDED ABOVE AND, IN NO EVENT, SHALL THE COMPANY'S LIABILITY EXCEED THE PURCHASE PRICE PAID BY PURCHASER FOR THE PRODUCT.

This Warranty is in lieu of all other express warranties or liabilities. ANY IMPLIED WARRANTIES, INCLUDING ANY IMPLIED WARRANTY OF MERCHANTABILITY, SHALL BE LIMITED TO THE DURATION OF THIS WRITTEN WARRANTY. ANY ACTION FOR BREACH OF ANY WARRANTY HEREUNDER INCLUDING ANY IMPLIED WARRANTY OF MERCHANTABILITY MUST BE BROUGHT WITH IN A PERIOD NOT EXCEEDING 12 MONTHS AFTER EXPIRATION OF THE WARRANTY. IN NO CASE SHALL THE COMPANY BE LIABLE FOR ANY CONSEQUENTIAL OR INCIDENTAL DAMAGES FOR BREACH OF THIS OR ANY OTHER WARRANTY. No person or representative is authorized to assume for the Company any liability other than expressed herein in connection with the sale of this product.

Some states do not allow limitations on how long an implied warranty lasts or the exclusion or limitation of incidental or consequential damage so the above limitations or exclusions may not apply to you. This Warranty gives you specific legal rights and you may also have other rights which vary from state to state.

Audiovox Electronics Corporation, 150 Marcus Blvd., Hauppauge, New York 11788 1-800-645-4994

128-7188B

